

KATALOG KLAMEK **2014**



PONADCZASOWA
ELEGANCJA



ZARZĄDZANIE JAKOŚCIĄ

Jesteśmy certyfikowani
według wymagań
ISO 9001:2008



KLAMKA INFINITA

Nagroda w konkursie Dobry Design 2013
organizowanym przez wydawcę magazynu
"Dobrze Mieszkaj" – Publikator Sp. z o.o.



Domino po raz
kolejny znalazło się
w gronie laureatów
rankingu Firm Rodzinnych
organizowanym
przez Newsweek

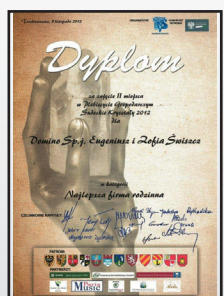

II MIEJSCE
w plebiscyde
„Sudeckie Kryształ”

Szanowni Państwo,

niniejszy katalog powstał z myślą o Państwa komforcie wyboru oraz ułatwieniu aranżacji wnętrza, która dzięki naszym produktom będzie czystą przyjemnością! Mamy nadzieję, że przejrzysta prezentacja szerokiego wachlarza okuć drzwiowych ułatwi Państwu podjęcie decyzji i zainspiruje do ciekawych połączeń, gwarantując satysfakcjonujący efekt końcowy.

Dbamy o najwyższą jakość naszych produktów – wszystkie posiadają certyfikat zgodności z PN EN 1906, wydany przez Instytut Techniki Budowlanej w Poznaniu, uprawniający do ich stosowania w budownictwie.

Oferujemy m.in.: klamki, wizjery, zawiasy, zamki, wkładki, odbojniki, tuleje do drzwi łazienkowych i wiele innych elementów z zakresu okuć drzwiowych, produkowanych przez renomowane firmy zachodnie.

Szczególnie polecamy bogaty wybór klamek do drzwi, w różnorodnych kształtach, kolorach i rodzajach. Wykonane z mosiądzu, aluminium lub stali nierdzewnej i znanu, szlifowane i poddane obróbce galwanicznej, nabrały dodatkowej odporności na ścieranie, zyskując unikalne właściwości kolorystyczne i efekty estetyczne.

Nasze klamki otwierają każde drzwi, także te do wyobraźni!

Zapewniamy partnerską współpracę, dokładając wszelkich starań w zakresie terminowości realizacji zleceń, fachowej obsługi oraz oferty produktów na najwyższym poziomie.

Serdecznie zapraszamy do współpracy!

Zofia i Eugeniusz Świszcz
Domino Sp.j.



Biuro przy ul. Rzeźniczej



Główny magazyn przy ul. Batalionów Chłopskich

Jak korzystać z katalogu?

Sharon-R

M3 MAT M6/M9

domino



Szyld 950

M3 MAT M6/M9

	Netto	Brutto
Klamka dzielona	48,79	60,01
Szyld BB PZ	12,92	15,89
Szyld WC	24,00	29,52

Rodzaj szyldu
 BB - klucz
 PZ - wkładka bębnekowa
 WC - łazienka

Dostępne kolory klamki

Szyld

Dostępne kolory szyldu

Cena katalogowa brutto

Cena katalogowa netto

Fly economy

DOBRA CENA

domino



M3 M9

	Netto	Brutto
Klamka BB B/O PZ	26,78	32,94
Klamka WC lewa prawa	31,54	38,79

Formy przebić
 BB - klucz
 PZ - wkładka bębnekowa
 B/O - bez otworu
 WC - łazienka
 lewa/prawa - strona

Producent

Dostępne kolory klamki

Cena katalogowa brutto

Cena katalogowa netto

Katalog nie stanowi oferty w myśl art. 71 k.c.

Klamki wewnętrzne

KLAMKI NA DZIELONYM SZYLDZIE KWADRATOWYM



Alma-QR



Szyld ALMA



	Netto	Brutto
Klamka dzielona	59,80	73,56
Szyld BB PZ	16,16	19,88
Szyld WC	21,22	26,10

Coral-QR



Szyld QUADRO



	Netto	Brutto
Klamka dzielona	64,46	79,29
Szyld BB PZ	18,31	22,52
Szyld WC	26,00	31,98

Dots-QR



Szyld QUADRO



	Netto	Brutto
Klamka dzielona	64,46	79,29
Szyld BB PZ	18,31	22,52
Szyld WC	26,00	31,98

Fenix-QR



Szyld QUADRO



	Netto	Brutto
Klamka dzielona	57,46	70,68
Szyld BB PZ	18,31	22,52
Szyld WC	26,00	31,98

Fero-QR



Szyld QUADRO



	Netto	Brutto
Klamka dzielona	42,63	52,43
Szyld BB PZ	18,31	22,52
Szyld WC	26,00	31,98

Figo-QR



Szyld QUADRO



	Netto	Brutto
Klamka dzielona	42,63	52,43
Szyld BB PZ	18,31	22,52
Szyld WC	26,00	31,98

Fokus-QR



Szyld QUADRO



	Netto	Brutto
Klamka dzielona	37,87	46,58
Szyld BB PZ	18,31	22,52
Szyld WC	26,00	31,98

Fremo-QR



Szyld QUADRO



	Netto	Brutto
Klamka dzielona	59,74	73,48
Szyld BB PZ	18,31	22,52
Szyld WC	26,00	31,98

Galaxy-QR



Szyld QUADRO



	Netto	Brutto
Klamka dzielona	48,79	60,01
Szyld BB PZ	18,31	22,52
Szyld WC	26,00	31,98

Gustaw-QR

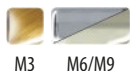

Szyld QUADRO

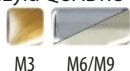

Netto Brutto

Klamka dzielona	61,53	75,68
Szyld BB PZ	18,31	22,52
Szyld WC	26,00	31,98

Iggy-QR

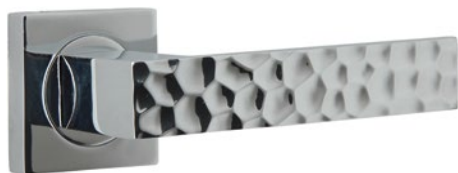

Szyld QUADRO



Netto Brutto

Klamka dzielona	64,46	79,29
Szyld BB PZ	18,31	22,52
Szyld WC	26,00	31,98

Insignia-QR



Szyld QUADRO



Netto Brutto

Klamka dzielona	36,77	45,23
Szyld BB PZ	18,31	22,52
Szyld WC	26,00	31,98

DOBRA
CENA

Jane-QR

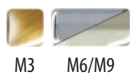

Szyld QUADRO



Netto Brutto

Klamka dzielona	53,69	66,04
Szyld BB PZ	18,31	22,52
Szyld WC	26,00	31,98

Jaro-QR



Szyld QUADRO



Netto Brutto

Klamka dzielona	59,74	73,48
Szyld BB PZ	18,31	22,52
Szyld WC	26,00	31,98

Jaro-QR ECO



Szyld QUADRO



Netto Brutto

Klamka dzielona	36,77	45,23
Szyld BB PZ	18,31	22,52
Szyld WC	26,00	31,98

DOBRA
CENA

Kyrk-QR



Szyld QUADRO



Netto Brutto

Klamka dzielona	61,53	75,68
Szyld BB PZ	18,31	22,52
Szyld WC	26,00	31,98

Logo-QR

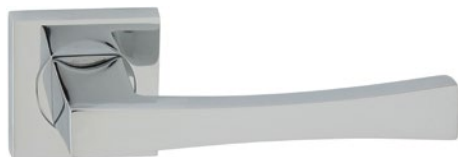

Szyld QUADRO



Netto Brutto

Klamka dzielona	64,46	79,29
Szyld BB PZ	18,31	22,52
Szyld WC	26,00	31,98

Milano-QR



Szyld QUADRO



Netto Brutto

Klamka dzielona	83,97	103,28
Szyld BB PZ	18,31	22,52
Szyld WC	26,00	31,98

Modena-QR



Net-QR



Omega-QR

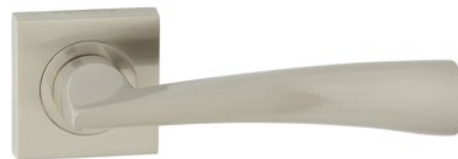

Szyld QUADRO



Netto Brutto

Klamka dzielona	64,46	79,29
Szyld BB PZ	18,31	22,52
Szyld WC	26,00	31,98

Szyld QUADRO



Netto Brutto

Klamka dzielona	64,46	79,29
Szyld BB PZ	18,31	22,52
Szyld WC	26,00	31,98

Szyld QUADRO



Netto Brutto

Klamka dzielona	40,63	49,98
Szyld BB PZ	18,31	22,52
Szyld WC	26,00	31,98

Palermo-QR



Presto-QR



DOBRA CENA

Qubik-QR

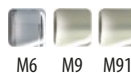

DOBRA CENA

Romana-QR



DOBRA CENA

Szyld QUADRO



Netto Brutto

Klamka dzielona	48,79	60,01
Szyld BB PZ	18,31	22,52
Szyld WC	26,00	31,98

Szyld QUADRO



Netto Brutto

Klamka dzielona	39,44	48,51
Szyld BB PZ	18,31	22,52
Szyld WC	26,00	31,98

Szyld QUADRO



Netto Brutto

Klamka dzielona	41,39	50,91
Szyld BB PZ	18,31	22,52
Szyld WC	26,00	31,98

Szyld QUADRO



Netto Brutto

Klamka dzielona	39,44	48,51
Szyld BB PZ	18,31	22,52
Szyld WC	26,00	31,98

Sky-QR



Time-QR



Tom-II-QR



Tre-QR

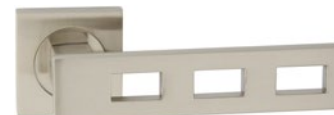

Szyld QUADRO



Netto Brutto

Klamka dzielona	56,14	69,06
Szyld BB PZ	18,31	22,52
Szyld WC	26,00	31,98

Szyld QUADRO



Netto Brutto

Klamka dzielona	63,50	78,10
Szyld BB PZ	18,31	22,52
Szyld WC	26,00	31,98

Szyld QUADRO



Netto Brutto

Klamka dzielona	48,79	60,01
Szyld BB PZ	18,31	22,52
Szyld WC	26,00	31,98

Szyld QUADRO



Netto Brutto

Klamka dzielona	48,79	60,01
Szyld BB PZ	18,31	22,52
Szyld WC	26,00	31,98

Klamki wewnętrzne

KLAMKI NA DZIELONYM SZYLDZIE OKRĄGŁYM



Afrodyta-R



M3



Szyld 900



M3

	Netto	Brutto
Klamka dzielona	66,11	81,32
Szyld BB PZ	13,69	16,84
Szyld WC	24,00	29,52

Alma-R



M3 M6 M9 SN



Szyld 980



M3 M6 M9 SN

	Netto	Brutto
Klamka dzielona	41,06	50,50
Szyld BB PZ	14,39	17,70
Szyld WC	22,85	28,11

Alma-R economy



M3 M4 M6 M6/M9 SN



Szyld 950



M3 M4 M6 M6/M9 SN

**DOBRA
CENA**

	Netto	Brutto
Klamka dzielona	26,78	32,94
Szyld BB PZ	12,92	15,89
Szyld WC	24,00	29,52

Anna-R



M3 MAT



Szyld 950



M3 MAT

	Netto	Brutto
Klamka dzielona	34,71	42,69
Szyld BB PZ	12,92	15,89
Szyld WC	24,00	29,52

Atena-R



M1 M3



Szyld 600



M1 M3

	Netto	Brutto
Klamka dzielona	62,89	77,36
Szyld BB PZ	13,85	17,04
Szyld WC	26,15	32,16

Ballen-R



M3 M9



Szyld 950



M3 M9

	Netto	Brutto
Klamka dzielona	26,00	31,98
Szyld BB PZ	12,92	15,89
Szyld WC	24,00	29,52

Bilbao-R



M3 M6/M9



Szyld 950



M3 M6/M9

	Netto	Brutto
Klamka dzielona	28,04	34,49
Szyld BB PZ	12,92	15,89
Szyld WC	24,00	29,52

Biskopt-R



biały brąz



Szyld Biskopt



biały brąz

	Netto	Brutto
Klamka dzielona	9,46	11,64
Szyld BB PZ	2,69	3,31
Szyld WC	6,31	7,76

Casablanca-R



M3 M9



Szyld 950



M3 M9

	Netto	Brutto
Klamka dzielona	28,89	35,53
Szyld BB PZ	12,92	15,89
Szyld WC	24,00	29,52

Econom-R



biały brąz



Szyld ECONOM



biały brąz

Netto **Brutto**

Klamka dzielona	6,91	8,50
Szyld BB PZ	1,85	2,28
Szyld WC	4,00	4,92

Elisabeth-R

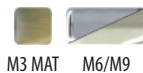

M3 MAT M6/M9



Szyld 950

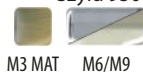

M3 MAT M6/M9

Netto **Brutto**

Klamka dzielona	43,91	54,01
Szyld BB PZ	12,92	15,89
Szyld WC	24,00	29,52

Fly-R economy

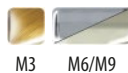

M3 M6/M9



**DOBRA
CENA**

Szyld 950

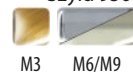

M3 M6/M9

Netto **Brutto**

Klamka dzielona	26,78	32,94
Szyld BB PZ	12,92	15,89
Szyld WC	24,00	29,52

Focus-R

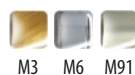

M3 M6 M91



M3 M6 M91

Netto **Brutto**

Klamka dzielona	37,87	46,58
Szyld BB PZ	12,92	15,89
Szyld WC	24,00	29,52

Galaxy-R



M6/M9

Szyld 950

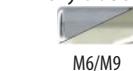

M6/M9

Netto **Brutto**

Klamka dzielona	47,18	58,03
Szyld BB PZ	12,92	15,89
Szyld WC	24,00	29,52

Gussy-R

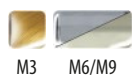

M3 M6/M9



M3 M6/M9

Netto **Brutto**

Klamka dzielona	47,37	58,27
Szyld BB PZ	12,92	15,89
Szyld WC	24,00	29,52

Ibis-R

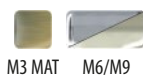

M3 MAT M6/M9



M3 MAT M6/M9

Netto **Brutto**

Klamka dzielona	28,05	34,50
Szyld BB PZ	12,92	15,89
Szyld WC	24,00	29,52

Insignia-R

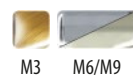

M3 M6/M9



M3 M6/M9

Netto **Brutto**

Klamka dzielona	28,05	34,50
Szyld BB PZ	12,92	15,89
Szyld WC	24,00	29,52

**DOBRA
CENA**

Jane-R



M6/M9



Szyld 950



M6/M9

	Netto	Brutto
Klamka dzielona	32,49	39,96
Szyld BB PZ	12,92	15,89
Szyld WC	24,00	29,52

Jane-R AG1



M9



Szyld JANE



M9

	Netto	Brutto
Klamka dzielona	32,49	39,96
Szyld BB PZ	7,54	9,27
Szyld WC	11,38	14,00

Jaro-R



M6/M9



Szyld 950



M6/M9

	Netto	Brutto
Klamka dzielona	48,00	59,04
Szyld BB PZ	12,92	15,89
Szyld WC	24,00	29,52

Jaro-R ECO



M6/M9



Szyld 950



M6/M9

	Netto	Brutto
Klamka dzielona	27,54	33,87
Szyld BB PZ	12,92	15,89
Szyld WC	24,00	29,52

Jola-R



M9



Szyld 950



M9

	Netto	Brutto
Klamka dzielona	28,89	35,53
Szyld BB PZ	12,92	15,89
Szyld WC	24,00	29,52

Kyrk-R



M10 M6/M9



Szyld 950



M10 M6/M9

	Netto	Brutto
Klamka dzielona	30,62	37,66
Szyld BB PZ	12,92	15,89
Szyld WC	24,00	29,52

Lavia-R



M6/M9



Szyld 950



M6/M9

	Netto	Brutto
Klamka dzielona	65,11	80,09
Szyld BB PZ	12,92	15,89
Szyld WC	24,00	29,52

Loft-R



M95



Szyld 950



M95

	Netto	Brutto
Klamka dzielona	47,37	58,27
Szyld BB PZ	12,92	15,89
Szyld WC	24,00	29,52

Malta-R



M3 MAT



Szyld 950



M3 MAT

	Netto	Brutto
Klamka dzielona	53,55	65,86
Szyld BB PZ	12,92	15,89
Szyld WC	24,00	29,52

Marion-R



M6/M9



Szyld 950



M6/M9

	Netto	Brutto
Klamka dzielona	48,79	60,01
Szyld BB PZ	12,92	15,89
Szyld WC	24,00	29,52

Modena-R



M3 M9



Szyld 950



M3 M9

	Netto	Brutto
Klamka dzielona	45,80	56,34
Szyld BB PZ	12,92	15,89
Szyld WC	24,00	29,52

Monaco-R



M3 M9



Szyld 950



M3 M9

	Netto	Brutto
Klamka dzielona	28,89	35,53
Szyld BB PZ	12,92	15,89
Szyld WC	24,00	29,52

Nova-R

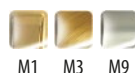

M1 M3 M9



Szyld NOVA



M1 M3 M9

	Netto	Brutto
Klamka dzielona	26,75	32,90
Szyld BB PZ	9,69	11,92
Szyld WC	12,92	15,89

Omega-R



M6/M9



Szyld 950



M6/M9

	Netto	Brutto
Klamka dzielona	43,91	54,01
Szyld BB PZ	12,92	15,89
Szyld WC	24,00	29,52

Oslo-R



M3 M9



Szyld 950



M3 M9

	Netto	Brutto
Klamka dzielona	28,89	35,53
Szyld BB PZ	12,92	15,89
Szyld WC	24,00	29,52

Otto-R

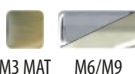

M3 MAT M6/M9



Szyld 950

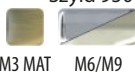

M3 MAT M6/M9

	Netto	Brutto
Klamka dzielona	30,85	37,95
Szyld BB PZ	12,92	15,89
Szyld WC	24,00	29,52

Palermo-R



M3 M9



Szyld 950



M3 M9

	Netto	Brutto
Klamka dzielona	38,03	46,78
Szyld BB PZ	12,92	15,89
Szyld WC	24,00	29,52

Petra-R

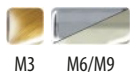

**DOBRA
CENA**



	Netto	Brutto
Klamka dzielona	28,05	34,50
Szyld BB PZ	12,92	15,89
Szyld WC	24,00	29,52

Presto-R

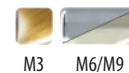

**DOBRA
CENA**



	Netto	Brutto
Klamka dzielona	26,78	32,94
Szyld BB PZ	12,92	15,89
Szyld WC	24,00	29,52

Pro-R



	Netto	Brutto
Klamka dzielona	13,06	16,06
Szyld BB PZ	4,46	5,49
Szyld WC	7,84	9,64

Romana-R

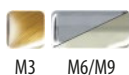

**DOBRA
CENA**



	Netto	Brutto
Klamka dzielona	28,05	34,50
Szyld BB PZ	12,92	15,89
Szyld WC	24,00	29,52

Sharon-R

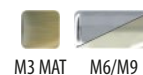

	Netto	Brutto
Klamka dzielona	48,79	60,01
Szyld BB PZ	12,92	15,89
Szyld WC	24,00	29,52

Tiger-R



	Netto	Brutto
Klamka dzielona	8,41	10,35
Szyld BB PZ	2,92	3,59
Szyld WC	5,54	6,81

Time-R



	Netto	Brutto
Klamka dzielona	58,60	72,08
Szyld BB PZ	13,85	17,04
Szyld WC	26,15	32,16

Wing-R



	Netto	Brutto
Klamka dzielona	46,10	56,70
Szyld BB PZ	13,85	17,04
Szyld WC	26,15	32,16

Klamki wewnętrzne

KLAMKI NA DŁUGIM SZYLDZIE



Afrodyta



Netto Brutto

Klamka BB | B/O | PZ **67,74** 83,32

Klamka WC **77,54** 95,37

Alma



Netto Brutto

Klamka BB | B/O | PZ **51,82** 63,74

Klamka WC lewa | prawa **63,22** 77,76

Alma economy

DOBRA
CENA



Netto Brutto

Klamka BB | B/O | PZ **31,54** 38,79

Klamka WC lewa | prawa **34,70** 42,68

Anna



Netto Brutto

Klamka BB | PZ | B/O **36,28** 44,62

Klamka WC lewa | prawa **39,93** 49,11

Ares



czarny

Netto Brutto

Klamka PZ 72/90 **32,56** 40,05

Atena



Netto Brutto

Klamka PZ | BB | B/O **68,12** 83,79

Klamka WC lewa | prawa **76,69** 94,33

Ballen



DOBRA
CENA



Netto Brutto

Klamka B/O | BB | PZ **26,00** 31,98

Klamka WC **30,62** 37,66

Bilbao

DOBRA
CENA



Netto Brutto

Klamka BB | B/O | PZ **34,86** 42,88

Klamka WC **41,20** 50,68

Biskopt



biały brąz

Netto Brutto

Klamka BB PZ	14,36	17,66
Klamka WC	18,92	23,27

Casablanca



M3 M9

Netto Brutto

Klamka B/O BB PZ	34,28	42,16
Klamka WC lewa prawa	42,44	52,20

Econom



biały brąz

Netto Brutto

Klamka B/O BB PZ	10,62	13,06
Klamka WC	12,28	15,10

Elizabeth



M6/M9

Netto Brutto

Klamka B/O BB PZ	34,28	42,16
Klamka WC lewa prawa	42,44	52,20

Fero



M91

Netto Brutto

Klamka B/O BB PZ	31,53	38,79
Klamka WC	36,29	44,63

Fly economy



M3 M9

Netto Brutto

Klamka BB B/O PZ	26,78	32,94
Klamka WC lewa prawa	31,54	38,79

Fokus



M3 M91

Netto Brutto

Klamka B/O BB PZ	33,12	40,74
Klamka WC	37,87	46,58

Galaxy



M6/M9

Netto Brutto

Klamka BB B/O PZ	48,81	60,03
Klamka WC	58,27	71,67

Giussy

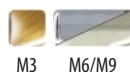

Netto Brutto

Klamka BB B/O PZ	58,23	71,62
Klamka WC lewa prawa	64,33	79,13

Hades P18



czarny

Netto Brutto

Klamka PZ 72/90	28,89	35,53
-----------------	--------------	-------

Ibis

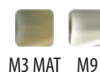

M3 MAT M9

Netto Brutto

Klamka BB B/O PZ	33,25	40,89
Klamka WC	42,44	52,20

Insignia

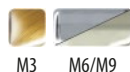

Netto Brutto

Klamka BB B/O PZ	33,28	40,93
Klamka WC	41,20	50,68

Istambul



M1 M3

Netto Brutto

Klamka BB B/O PZ	68,55	84,32
Klamka WC lewa prawa	94,18	115,84

Jane

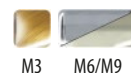

M3 M6/M9

Netto Brutto

Klamka BB B/O	53,70	66,06
Klamka WC lewa prawa	59,08	72,66
Klamka PZ lewa prawa	66,76	82,12

Jaro



M6/M9

Netto Brutto

Klamka BB B/O PZ	60,06	73,87
Klamka WC lewa prawa	73,21	90,05

Jaro economy



M6/M9

Netto Brutto

Klamka BB B/O PZ	30,62	37,66
Klamka WC	35,23	43,33

Jola

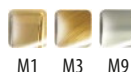

M1 M3 M9

Netto Brutto

Klamka BB PZ B/O	27,59	33,93
Klamka WC	32,49	39,96

Kyrk



Netto Brutto

Klamka BB B/O PZ	30,62	37,66
Klamka WC lewa prawa	33,69	41,44

Loft



Netto Brutto

Klamka BB B/O PZ	58,47	71,92
Klamka WC	61,63	75,80

Malta



Netto Brutto

Klamka BB B/O PZ	62,02	76,29
Klamka WC lewa prawa	69,87	85,94

Modena



Netto Brutto

Klamka BB PZ B/O	41,03	50,47
Klamka WC	50,39	61,97

Monaco



Netto Brutto

Klamka BB B/O PZ	34,28	42,16
Klamka WC	42,44	52,20

Nova



Netto Brutto

Klamka BB B/O PZ	25,62	31,52
Klamka WC	32,49	39,96

Oslo



Netto Brutto

Klamka B/O BB PZ	34,28	42,16
Klamka WC lewa prawa	42,44	52,20

Otto

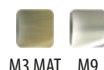

Netto Brutto

Klamka BB B/O PZ	35,91	44,17
Klamka WC lewa prawa	44,56	54,81

Palermo



Netto Brutto

Klamka BB B/O PZ	42,26	51,98
Klamka WC	51,90	63,83

Petra

DOBRA
CENA



Netto Brutto

Klamka BB | B/O | PZ **34,86** 42,88

Klamka WC **41,20** 50,68

Presto

DOBRA
CENA

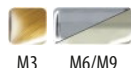

Netto Brutto

Klamka BB | B/O | PZ **28,36** 34,88

Klamka WC lewa | prawa **31,51** 38,76

Pro



Netto Brutto

Klamka B/O | BB | PZ **16,97** 20,88

Klamka WC **20,38** 25,07

Romana

DOBRA
CENA



Netto Brutto

Klamka BB | B/O | PZ **34,86** 42,88

Klamka WC **41,20** 50,68

Tiger



Netto Brutto

Klamka B/O | BB | PZ **12,95** 15,92

Klamka WC **15,64** 19,24

Time



Netto Brutto

Klamka BB | B/O | PZ **30,62** 37,66

Klamka WC **33,69** 41,44

Tre



Netto Brutto

Klamka BB | B/O | PZ **37,38** 45,98

Klamka WC **47,33** 58,22

Wing



Netto Brutto

Klamka BB | B/O | PZ **49,14** 60,44

Klamka WC lewa | prawa **56,97** 70,07

Klamki wewnętrzne

KLAMKI ZE STALI NIERDZEWNEJ



Agnessa-QR



Szyld EF SN04
INX

	Netto	Brutto
Klamka dzielona	43,54	53,55
Szyld BB PZ	16,00	19,68
Szyld WC	22,46	27,63

Amir 2230-R



Szyld EF100
INX

	Netto	Brutto
Klamka dzielona	66,40	81,67
Szyld BB PZ	12,15	14,94
Szyld B/O	19,85	24,42
Szyld WC	38,46	47,31

Aveiro-QR



Szyld EF KWADRAT
INX

	Netto	Brutto
Klamka dzielona	149,75	184,19
Szyld BB PZ	20,00	24,60
Szyld B/O	24,30	29,89
Szyld WC	44,62	54,88

Finger 2252-QR



Szyld EF KWADRAT
INX

	Netto	Brutto
Klamka dzielona	153,39	188,67
Szyld BB PZ	20,00	24,60
Szyld B/O	24,30	29,89
Szyld WC	44,62	54,88

Finger 2252-R



Szyld EF 100
INX

	Netto	Brutto
Klamka dzielona	153,39	188,67
Szyld BB PZ	12,15	14,94
Szyld B/O	19,85	24,42
Szyld WC	38,46	47,31

Golf 2233-R



Szyld EF 100
INX

	Netto	Brutto
Klamka dzielona	66,40	81,67
Szyld BB PZ	12,15	14,94
Szyld B/O	19,85	24,42
Szyld WC	38,46	47,31

Grisza-QR



Szyld SN04
INX

	Netto	Brutto
Klamka dzielona	43,54	53,55
Szyld BB PZ	16,00	19,68
Szyld WC	22,46	27,63

Image 2002-QR



Szyld EF KWADRAT
INX

	Netto	Brutto
Klamka dzielona	103,00	126,69
Szyld BB PZ	20,00	24,60
Szyld B/O	24,30	29,89
Szyld WC	44,62	54,88

Image 2002-R



Szyld EF 100
INX

	Netto	Brutto
Klamka dzielona	66,40	81,67
Szyld BB PZ	12,15	14,94
Szyld B/O	19,85	24,42
Szyld WC	38,46	47,31

Image 2072

TUPAI



Szyld EF OWAL

	Netto	Brutto
Klamka dzielona	56,89	69,97
Szyld PZ	20,00	24,60



Lido 2001-R

TUPAI



Szyld EF 100

	Netto	Brutto
Klamka dzielona	66,40	81,67
Szyld BB PZ	12,15	14,94
Szyld B/O	19,85	24,42
Szyld WC	38,46	47,31



Lido 2071

TUPAI



Szyld EF OWAL

	Netto	Brutto
Klamka dzielona	56,89	69,97
Szyld PZ	20,00	24,60



Liu-R

domino



Szyld EF LUI

	Netto	Brutto
Klamka dzielona	30,62	37,66
Szyld BB PZ	12,15	14,94
Szyld WC	24,62	30,28



Luka-QR

domino



Szyld SN04

	Netto	Brutto
Klamka dzielona	43,54	53,55
Szyld BB PZ	16,00	19,68
Szyld WC	22,46	27,63



Padwa-R

domino



Szyld EF LUI

	Netto	Brutto
Klamka dzielona	36,77	45,23
Szyld BB PZ	12,15	14,94
Szyld WC	24,62	30,28



Prado-R

domino



Szyld EF LUI

	Netto	Brutto
Klamka dzielona	30,62	37,66
Szyld BB PZ	12,15	14,94
Szyld WC	24,62	30,28



Prima 2232-R

TUPAI



Szyld EF 100

	Netto	Brutto
Klamka dzielona	66,40	81,67
Szyld BB PZ	12,15	14,94
Szyld B/O	19,85	24,42
Szyld WC	38,46	47,31



Rondo 2000-R

TUPAI



Szyld EF 100

	Netto	Brutto
Klamka dzielona	66,40	81,67
Szyld BB PZ	12,15	14,94
Szyld B/O	19,85	24,42
Szyld WC	38,46	47,31



Rondo 2003



TUPAI

	Netto	Brutto
Klamka BB B/O PZ	137,86	169,57
Klamka WC	151,33	186,14



Rondo 2003/2006

Lewa lub prawa



TUPAI



	Netto	Brutto
Klamka PZ lewa prawa	196,50	241,69

Rondo 2070

TUPAI



Szyld EF OWAL



	Netto	Brutto
Klamka dzielona	56,89	69,97
Szyld PZ	20,00	24,60

Siena-R

domino



INX/ INX POLER

Szyld EF LUI



	Netto	Brutto
Klamka dzielona	36,77	45,23
Szyld BB PZ	12,15	14,94
Szyld WC	24,62	30,28

Sigma-QR

domino



Szyld SN04



	Netto	Brutto
Klamka dzielona	41,39	50,90
Szyld BB PZ	16,00	19,68
Szyld WC	22,46	27,63

Sigma-R

domino



Szyld EF LUI



	Netto	Brutto
Klamka dzielona	30,62	37,66
Szyld BB PZ	12,15	14,94
Szyld WC	24,62	30,28

Sigma-R Owal

domino



Szyld EF OWAL



	Netto	Brutto
Klamka dzielona	30,62	37,66
Szyld PZ	20,00	24,60

Uno



domino



	Netto	Brutto
Klamka B/O BB PZ	55,39	68,13
Klamka WC	71,23	87,62

Uno Gałka



domino



	Netto	Brutto
Gałka PZ	55,23	67,93

Uno 170



domino



	Netto	Brutto
Klamka PZ	52,16	64,16

Uno 170 Gałka



domino



	Netto	Brutto
Gałka PZ	55,23	67,93

Uno-R

domino



Szyld EF LUI



	Netto	Brutto
Klamka dzielona	30,62	37,66
Szyld BB PZ	12,15	14,94
Szyld WC	24,62	30,28

Uno-R Owal

domino



Szyld EF OWAL



	Netto	Brutto
Klamka dzielona	30,62	37,66
Szyld PZ	20,00	24,60

SZYLDY



001



BB

PZ

WC



	Netto	Brutto
Szyld BB PZ	12,15	14,94
Szyld WC	16,30	20,05



980



BB

PZ

WC



	Netto	Brutto
Szyld BB PZ	14,39	17,70
Szyld WC	22,85	28,11



600



BB

PZ

WC



	Netto	Brutto
Szyld BB PZ	13,85	17,04
Szyld WC	26,15	32,16



AlmaQ



BB

PZ

WC

	Netto	Brutto
Szyld BB PZ	16,16	19,88
Szyld WC	21,22	26,10



900



BB

PZ

WC



	Netto	Brutto
Szyld BB PZ	13,69	16,84
Szyld WC	24,00	29,52



Econom



BB

PZ

WC

	Netto	Brutto
Szyld BB PZ	1,85	2,28
Szyld WC	4,00	4,92



950



BB

PZ

WC



	Netto	Brutto
Szyld BB PZ	12,92	15,89
Szyld WC	24,00	29,52



EF KWADRAT INX



BB

PZ

WC

B/O

	Netto	Brutto
Szyld BB PZ	20,00	24,60
Szyld B/O	24,30	29,89
Szyld WC	44,62	54,88



EF OWAL



	Netto	Brutto
Szyld PZ	20,00	24,60



Jane AG1



BB PZ WC

	Netto	Brutto
Szyld BB PZ	7,54	9,27
Szyld WC	12,15	14,94



EF-100



BB PZ WC B/O

	Netto	Brutto
Szyld BB PZ	12,15	14,94
Szyld B/O	19,85	24,42
Szyld WC	38,46	47,31



Nova



BB PZ WC

	Netto	Brutto
Szyld BB PZ	9,69	11,92
Szyld WC	12,92	15,89



EF-200



	Netto	Brutto
Szyld WC	24,62	30,28



Pro



BB PZ WC

	Netto	Brutto
Szyld BB PZ	4,46	5,49
Szyld WC	7,84	9,64

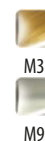

EF-lui



BB PZ WC

	Netto	Brutto
Szyld BB PZ	12,15	14,94
Szyld WC	24,62	30,28



QUADRO



BB PZ WC

	Netto	Brutto
Szyld BB PZ	18,31	22,52
Szyld WC	26,00	31,98

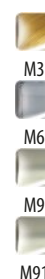

QUADRO M6/M9



BB

PZ

WC

	Netto	Brutto
Szylid BB PZ	18,31	22,52
Szylid WC	26,00	31,98



Tiger



BB

PZ

WC

	Netto	Brutto
Szylid BB PZ	2,92	3,59
Szylid WC	5,54	6,81



SN04



BB

PZ

WC

	Netto	Brutto
Szylid BB PZ	16,00	19,68
Szylid WC	22,46	27,63



SP Biskopt



BB

PZ

WC

	Netto	Brutto
Szylid BB PZ	2,69	3,31
Szylid WC	6,31	7,76



GAŁKI

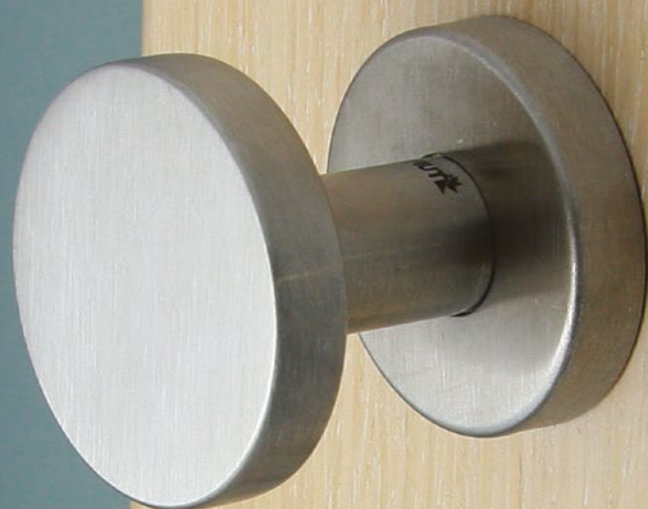

1924-Q

TUPAI



Szyld KWADRAT
M9

	Netto	Brutto
Gałka ruchoma (kpl.)	196,96	242,26
Gałka stała (szt.) lewa prawa	106,14	130,55
Szyld BB PZ	21,54	26,49
Szyld WC	47,69	58,66



2006

TUPAI



Szyld EF 100
INX

	Netto	Brutto
Gałka ruchoma (kpl.)	291,58	358,64
Gałka stała (szt.)	145,79	179,32
Szyld B/O	19,85	24,42
Szyld BB PZ	12,15	14,94
Szyld WC	38,46	47,31



2055

domino



Szyld LUI
INX

	Netto	Brutto
Gałka ruchoma (szt.)	37,56	46,19
Gałka stała (szt.)	37,56	46,19
Szyld BB PZ	12,15	14,94
Szyld WC	24,62	30,28

2065

domino



Szyld KWADRAT
M6/M9

	Netto	Brutto
Gałka ruchoma (szt.)	39,62	48,73
Gałka stała (szt.)	39,62	48,73
Szyld BB PZ	18,31	22,52
Szyld WC	26,00	31,98



2075

domino



Szyld 950
M3 M6/M9

	Netto	Brutto
Gałka ruchoma (szt.)	39,62	48,73
Gałka stała (szt.)	39,62	48,73
Szyld BB PZ	12,92	15,89
Szyld WC	24,00	29,52

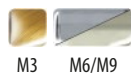

Klamka Alma+G

domino



	Netto	Brutto
Gałka PZ	49,23	60,56
Klamka Alma + Gałka PZ	60,22	74,07

6711 Prosta

domino



Gałka z zamkiem

	Netto	Brutto
Gałka	30,62	37,66

6871 Kula

domino

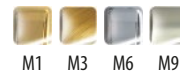

Gałka z zamkiem

	Netto	Brutto
Gałka	30,62	37,66

KLAMKI DO DRZWI ZEWNĘTRZNYCH



AXA K+K

Szyld AXA

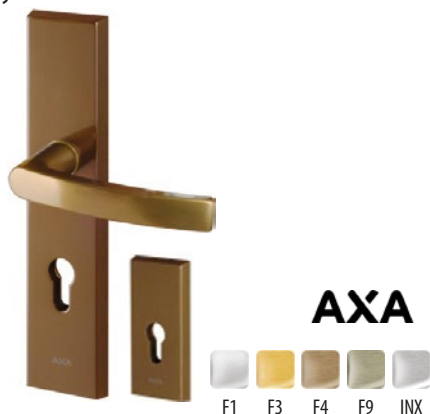

	Netto	Brutto
Klamka PZ kl. III	163,00	200,49
Szyld kl. III	84,00	103,32

Fokus K+K

Szyld Fokus



	Netto	Brutto
Klamka PZ	66,00	81,18
Szyld	26,00	31,98

Galaxy K+K

Szyld zewnętrzny 800



	Netto	Brutto
Klamka dzielona lewa prawa	43,91	54,01
Szyld	13,47	16,57

Haga K+K

Szyld Haga



	Netto	Brutto
Klamka PZ	83,00	102,09
Szyld długi kl. I	36,00	44,28
Szyld krótki kl. I	33,00	40,59

Jane K+K

Szyld Jane



	Netto	Brutto
Klamka PZ lewa prawa	66,76	82,12
Szyld	29,22	35,94

Lana K+K

Szyld DIEC 7037



	Netto	Brutto
Klamka PZ	136,44	167,82
Szyld	83,16	102,29

Lana K+P

Szyld DIEC 7037



	Netto	Brutto
Klamka PZ	156,91	193,00
Szyld	83,16	102,29

Manitoba K+K

Szyld Manitoba



	Netto	Brutto
Klamka PZ kl. I lewa prawa	90,00	110,70
Szyld długi kl. I	42,00	51,66
Szyld krótki kl. I	33,00	40,59

Marseille K+K

Szyld 42KVS



	Netto	Brutto
Klamka PZ kl. III	204,97	252,12
Szyld PZ	51,92	63,87

Nestor K+K

Szyld Nestor



AXA



Netto **Brutto**

Klamka PZ kl. I	88,15	108,42
Szyld kl. I	36,36	44,72

New York K+K

Szyld 42KVS



Netto **Brutto**

Klamka PZ kl. III	204,97	252,12
Szyld PZ	51,92	63,87

Niagara K+K

Szyld Niagara



AXA



Netto **Brutto**

Klamka PZ kl. I	79,00	97,17
Szyld długi kl. I	36,00	44,28
Szyld krótki kl. I	33,00	40,59

Niagara K+P

Szyld Niagara



AXA



Netto **Brutto**

Klamka PZ kl. I	90,00	110,70
Szyld długi kl. I	36,00	44,28
Szyld krótki kl. I	33,00	40,59

Note K+K

Szyld Note



AXA



Netto **Brutto**

Klamka PZ kl. I lewa prawa	88,15	108,42
Klamka PZ kl. III lewa prawa	163,17	200,70
Szyld kl. I	36,41	44,78
Szyld kl. III	88,04	108,29

Note K+K z zabezpieczeniem

Szyld Note z zabezpieczeniem



AXA



Netto **Brutto**

Klamka PZ kl. III lewa prawa	187,43	230,54
Szyld kl. III	110,23	135,58

Note K+P

Szyld Note



AXA



Netto **Brutto**

Klamka PZ kl. I lewa prawa	99,19	122,01
Klamka PZ kl. III lewa prawa	174,20	214,27
Szyld kl. I	36,41	44,78
Szyld kl. III	88,04	108,29

Note K+P z zabezpieczeniem

Szyld Note z zabezpieczeniem



AXA



Netto **Brutto**

Klamka PZ kl. III lewa prawa	198,48	244,13
Szyld kl. III	110,23	135,58

Omega-zew. K+K

Szyld zewnętrzny 800

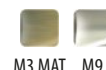
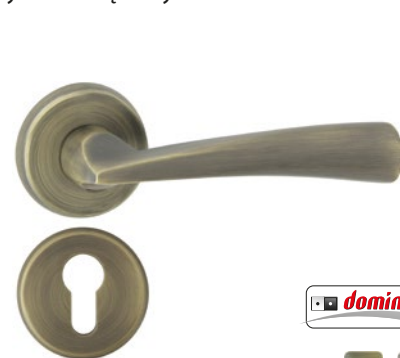

Netto **Brutto**

Klamka dzielona lewa prawa	43,91	54,01
Szyld	13,47	16,57

Ottawa K+K

Szyld Ottawa



	Netto	Brutto
Klamka PZ	65,00	79,95
Szyld	25,00	30,75

Prestige K+G

Szyld Prestige



	Netto	Brutto
Klamka PZ kl. III	179,52	220,81
Szyld długi kl. III	88,00	108,24
Szyld krótki kl. III	88,00	108,24

Prestige K+G z zabezpieczeniem

Szyld Prestige z zabezpieczeniem



	Netto	Brutto
Klamka PZ kl. III	203,00	249,69
Szyld długi kl. III	112,00	137,76
Szyld krótki kl. III	112,00	137,76

Prestige K+K

Szyld Prestige



	Netto	Brutto
Klamka PZ kl. III	169,00	207,87
Szyld długi kl. III	88,00	108,24
Szyld krótki kl. III	88,00	108,24

Prestige K+K z zabezpieczeniem

Szyld Prestige z zabezpieczeniem



	Netto	Brutto
Klamka PZ kl. III	191,00	234,93
Szyld krótki kl. III	112,00	137,76

Quebec K+K

Szyld Quebec



	Netto	Brutto
Klamka PZ kl. III	163,00	200,49
Szyld kl. III	84,00	103,32

Retro K+K

Szyld retro



	Netto	Brutto
Klamka PZ lewa prawa	188,00	231,24
Szyld krótki	99,00	121,77

Rondo K+G

Szyld DIEC 7030



	Netto	Brutto
Klamka PZ	127,50	156,83
Szyld	103,65	127,49

Rondo K+G z zabezpieczeniem

Szyld DIEC 7031



	Netto	Brutto
Klamka PZ	225,21	277,01
Szyld	178,18	219,16

Rondo K+K

Szyld DIEC 7030



	Netto	Brutto
Klamka PZ	139,08	171,07
Szyld	103,65	127,49

Rondo K+K z zabezpieczeniem

Szyld DIEC 7031



	Netto	Brutto
Klamka PZ	225,21	277,01
Szyld	178,18	219,16

Royal K+K

Szyld Royal

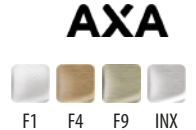

	Netto	Brutto
Klamka PZ kl. III	169,00	207,87
Szyld kl. III	88,00	108,24

Royal K+K z zabezpieczeniem

Szyld ROYAL z zabezpieczeniem

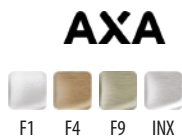

	Netto	Brutto
Klamka PZ kl. III	191,00	234,93
Szyld kl. III	112,00	137,76

Slim K+K

Szyld Slim



	Netto	Brutto
Klamka PZ	79,00	97,17
Szyld	47,00	57,81

Space K+K

Szyld Space



	Netto	Brutto
Klamka PZ lewa prawa	54,67	67,24
Szyld	23,60	29,03

Space K+K z zabezpieczeniem

Szyld Space z zabezpieczeniem



	Netto	Brutto
Klamka PZ lewa prawa	67,98	83,62
Szyld	39,46	48,54

Stratos K+K

Szyld Stratos



	Netto	Brutto
Klamka PZ kl. II	104,80	128,90
Szyld kl. II	44,13	54,28

Tokyo K+K

Szyld 42KVS



	Netto	Brutto
Klamka PZ kl. III	161,68	198,87
Szyld PZ	51,92	63,87

Dostępne rozstawy klamek do drzwi zewnętrznych

	F1	F2	F3	F4	F9	INX	M3	M3/Mat	M9	M6/M9	M91
AXA K+K PZ72	n/z		n/z	n/z	n/z	n/z					
Fokus K+K PZ72								D	D		
Galaxy K+K zew.								D	D		
Haga K+K PZ72	D		D	D	D	D					
Haga K+K PZ90	n/z		n/z	n/z	n/z	n/z					
Haga K+K PZ92	n/z		n/z	n/z	n/z	n/z					
Jane K+K PZ72							D			D	
Jane K+K PZ90							D			D	
Jane K+K PZ92							D			D	
Lana K+K PZ72	D			D							
Lana K+K PZ92	D			D							
Lana K+P PZ72	D			D							
Lana K+P PZ92	D			D							
Manitoba K+K PZ72	n/z		n/z	n/z	n/z	n/z					
Marseille K+K PZ72 kl. III				D	D						
Marseille K+K PZ92 kl. III				D	D						
Nestor K+K PZ72	n/z			n/z	n/z						
Nestor K+K PZ90	n/z			n/z	n/z						
Nestor K+K PZ92	n/z			n/z	n/z						
New York K+K PZ72 kl. III				D	D						
New York K+K PZ92 kl. III				D	D						
Niagara K+K PZ72	D		D	D	D	D					
Niagara K+K PZ90	n/z		n/z	n/z	n/z	n/z					
Niagara K+K PZ92	n/z		n/z	n/z	n/z	n/z					
Niagara K+P PZ72	n/z		n/z	n/z	n/z	n/z					
Niagara K+P PZ90	n/z		n/z	n/z	n/z	n/z					
Niagara K+P PZ92	n/z		n/z	n/z	n/z	n/z					
Note K+K PZ72 kl. I	n/z			n/z	n/z						
Note K+K PZ90 kl. I	n/z			n/z	n/z						
Note K+K PZ92 kl. I	n/z			n/z	n/z						
Note K+K PZ72 kl. III	n/z			n/z	n/z						
Note K+K PZ90 kl. III	n/z			n/z	n/z						
Note K+K PZ92 kl. III	n/z			n/z	n/z						
Note K+K PZ72 kl. III z zab.	n/z			n/z	n/z						
Note K+K PZ90 kl. III z zab.	n/z			n/z	n/z						
Note K+K PZ92 kl. III z zab.	n/z			n/z	n/z						
Note K+P PZ72 kl. I	n/z			n/z	n/z						
Note K+P PZ90 kl. I	n/z			n/z	n/z						
Note K+P PZ92 kl. I	n/z			n/z	n/z						
Note K+P PZ72 kl. III	n/z			n/z	n/z						
Note K+P PZ90 kl. III	n/z			n/z	n/z						
Note K+P PZ92 kl. III	n/z			n/z	n/z						
Note K+P PZ72 kl. III z zab.	n/z			n/z	n/z						
Note K+P PZ90 kl. III z zab.	n/z			n/z	n/z						
Note K+P PZ92 kl. III z zab.	n/z			n/z	n/z						
Omega K+K zew.								D	D		
Ottawa K+K PZ72	D		D	D	D	D					
Prestige K+K PZ72 kl. III	D		D	D	D	D					
Prestige K+K PZ90 kl. III	n/z		n/z	n/z	n/z	n/z					
Prestige K+K PZ92 kl. III	n/z		n/z	n/z	n/z	n/z					
Prestige K+K PZ72 kl. III z zab.	n/z		n/z	n/z	n/z	n/z					
Prestige K+K PZ90 kl. III z zab.	n/z		n/z	n/z	n/z	n/z					
Prestige K+K PZ92 kl. III z zab.	n/z		n/z	n/z	n/z	n/z					
Prestige K+G PZ72 kl. III	n/z		n/z	n/z	n/z	n/z					
Prestige K+G PZ90 kl. III	n/z		n/z	n/z	n/z	n/z					
Prestige K+G PZ92 kl. III	n/z		n/z	n/z	n/z	n/z					
Prestige K+G PZ72 kl. III z zab.	n/z		n/z	n/z	n/z	n/z					
Prestige K+G PZ90 kl. III z zab.	n/z		n/z	n/z	n/z	n/z					
Prestige K+G PZ92 kl. III z zab.	n/z		n/z	n/z	n/z	n/z					
Quebec K+K PZ72	n/z		n/z	n/z	n/z	n/z					
Retro K+K PZ72	n/z		n/z	n/z	n/z						
Rondo K+G PZ72		n/z	D	D							
Rondo K+G PZ72 z zab.		n/z	D	D							
Rondo K+K PZ72		n/z	D	D							
Rondo K+K PZ72 z zab.		n/z	D	D							
Royal K+K PZ72	n/z		n/z	n/z	n/z	n/z					
Royal K+K PZ72 z zab.	n/z		n/z	n/z	n/z	n/z					
Slim K+K PZ72	n/z		n/z	n/z	n/z	n/z					
Space K+K PZ72							D			D	
Space K+K PZ72 z zab.							D			D	
Stratos K+K PZ72 kl. II	n/z			n/z	n/z						
Tokyo K+K PZ72 kl. III				D	D						

D - dostępne | n/z - na zamówienie, czas realizacji: 4 tygodnie

KLAMKI OKIENNE



Agueda-QO

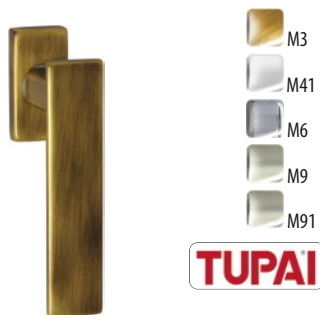

TUPAI

Netto Brutto

Klamka okienna **118,48** 145,73

Amir-O



TUPAI

Netto Brutto

Klamka okienna **51,69** 63,58

Aveiro-QO



TUPAI

Netto Brutto

Klamka okienna **93,69** 115,24

Demeter-O



TUPAI

Netto Brutto

Klamka okienna **104,65** 128,72

Faro-QO



TUPAI

Netto Brutto

Klamka okienna **118,48** 145,73

Finger-QO



TUPAI

Netto Brutto

Klamka okienna **94,08** 115,72

Golf-O



TUPAI

Netto Brutto

Klamka okienna **51,69** 63,58

Image-QO



TUPAI

Netto Brutto

Klamka okienna **51,69** 63,58

Kora-O



TUPAI

Netto Brutto

Klamka okienna **88,48** 108,83

Lamia-O



ROSSETTI

Netto Brutto

Klamka okienna **86,91** 106,90

Lido-O



TUPAI

Netto Brutto

Klamka okienna **58,39** 71,81

Lizbona-QO

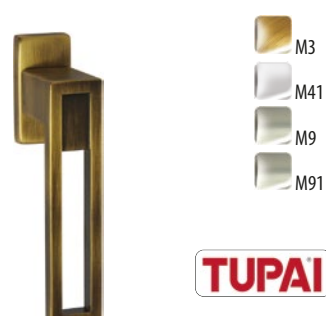

TUPAI

Netto Brutto

Klamka okienna **118,48** 145,73

Mateo-O



ROSSETTI

Netto Brutto

Klamka okienna **72,08** 88,66

Neris-QO



TUPAI

Netto Brutto

Klamka okienna **77,71** 95,58

Panteon-QO



TUPAI

Netto Brutto

Klamka okienna **88,48** 108,83

Pluton-O



domino

Netto Brutto

Klamka okienna **4,62** 5,68

Pluton-O

+ zamek



Netto Brutto

Klamka okienna **42,78** 52,62

Pluton-O

+ zamek



Netto Brutto

Klamka okienna **21,99** 27,05

Pluton-O

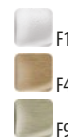

Netto Brutto

Klamka okienna **8,00** 9,84

Pombal-QO



Netto Brutto

Klamka okienna **118,48** 145,73

Porto-QO



Netto Brutto

Klamka okienna **118,48** 145,73

Prima-O



Netto Brutto

Klamka okienna **51,69** 63,58

Roma-O



Netto Brutto

Klamka okienna **90,10** 110,82

Rondo-O



Netto Brutto

Klamka okienna **51,69** 63,58

Scorpius-O



Netto Brutto

Klamka okienna **108,46** 133,41

Secustic-O

T35 do drewna



Netto Brutto

Klamka okienna **17,42** 21,42

Secustic-O

T32 do PCV

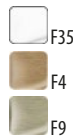

Netto Brutto

Klamka okienna **17,42** 21,42

Secustic-O

z kluczykiem



Netto Brutto

Klamka okienna **84,62** 104,08

Secustic-O

z przyciskiem



Netto Brutto

Klamka okienna **75,38** 92,72

Victoria-QO



Netto Brutto

Klamka okienna **118,48** 145,73

Vigo-QO



Netto Brutto

Klamka okienna **118,48** 145,73

Wenus-O



Netto Brutto

Klamka okienna **2,15** 2,64

Westa-O



Netto Brutto

Klamka okienna **100,79** 123,97

Zita-O



Netto Brutto

Klamka okienna **115,55** 142,13

AKCESORIA



Zamek do drzwi szklanych V-100



M9

Przeciwkaseta



Rygiel



Zawias V102



Rączki pasujące do zamka V-100

Aquila-R
Helena-R
Xenia-R
Astoria-R
Delphi-R
Lavinia-R
Hera-RS-R
Lamia-R
Zita-R
Pallas-R
Roma-R

- Zamek bez otworu lub z otworem na wkładkę bębnową.
- Zamek bez klamki w komplecie. Modele klamek pasujące do zamka w tabeli obok.
- Zestaw zawiera: zamek, zawiasy, osłonki na zawias i zestaw montażowy.



	Netto	Brutto
Zamek V-100	925,48	1138,34
Rygiel	243,20	299,13
Przeciwkaseta	804,70	989,78
Zawias V102	243,20	299,13

Zamek do drzwi szklanych V-5000



M9

- Zamek bez otworu lub z otworem na wkładkę bębnową.
- Zestaw zawiera: zamek, zawiasy, osłonki na zawias i zestaw montażowy.
- Zestaw z klamką Sky w komplecie.



	Netto	Brutto
Zamek + klamka	681,40	838,12

Zamek do drzwi szklanych V-6000



M9

- Zamek bez otworu, z otworem na wkładkę bębnową lub WC.
- Zestaw zawiera: zamek, zawiasy, osłonki na zawias i zestaw montażowy.
- Zestaw z klamką Uno w komplecie.



	Netto	Brutto
Zamek + klamka	570,47	701,68
Zamek WC + klamka	713,17	877,20

Pochwyty 092 mosiężny



	M1	M3	M4	M6	M9
Netto	28,38	28,38	32,75	32,75	36,78
Brutto	34,91	34,91	40,29	40,29	45,24

Pochwyty 095 mosiężny



	M1	M3	M4	M6	M9
Netto	25,53	25,53	30,24	30,24	30,24
Brutto	31,40	31,40	37,19	37,19	37,19

Pochwyty magnetyczny ZnAl 2649



	M3 MAT	M4	M6	M9
Netto	43,58	40,41	40,41	40,41
Brutto	53,60	49,70	49,70	49,70

Pochwyty magnetyczny ZnAl 2650



	M3 MAT	M4	M6	SN
Netto	56,26	48,33	48,33	48,33
Brutto	69,19	59,45	59,45	59,45

Pochwyty 090 ZnAl

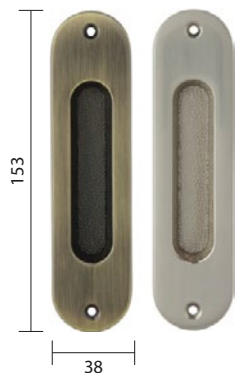

	M3	M9
Netto	28,38	28,38
Brutto	34,91	34,91

Pochwyty 3524 mosiężny



	M1	M3	M4	M6	M9
Netto	20,49	20,49	22,17	22,17	22,17
Brutto	25,20	25,20	27,27	27,27	27,27

Pochwyty stal nierdzewna

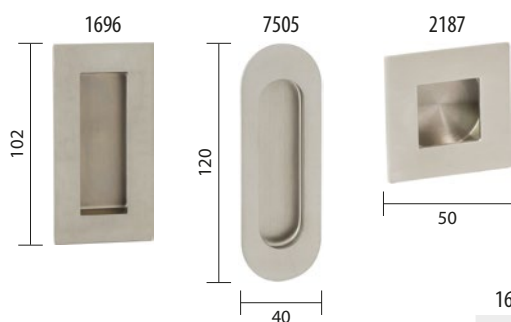

	1696	2187	7505
Netto	24,40	26,46	23,61
Brutto	30,02	32,55	29,04

Pochwyty stal nierdzewna

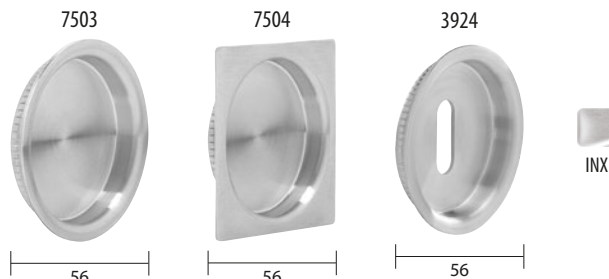

	7503	7504	3924
Netto	17,27	17,27	17,27
Brutto	21,25	21,25	21,25

Pochwyty stal nierdzewna

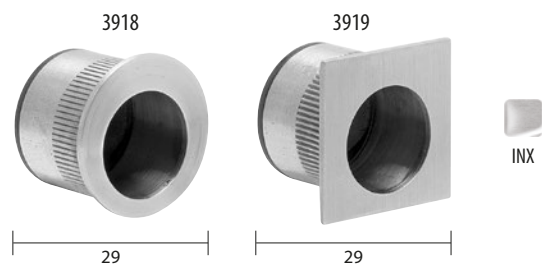

	3918	3919
Netto	15,69	15,69
Brutto	19,30	19,30

Pochwyty tworzywo



	biały	brąz	złoty	nikiel	orzech jasny
Netto	2,36	2,36	3,15	3,15	2,36
Brutto	2,90	2,90	3,88	3,88	2,90

Pochwyty balkonowy



	biały	brąz	M10
Netto	4,15	4,15	4,15
Brutto	5,11	5,11	5,11

Pochwyty aluminiowy

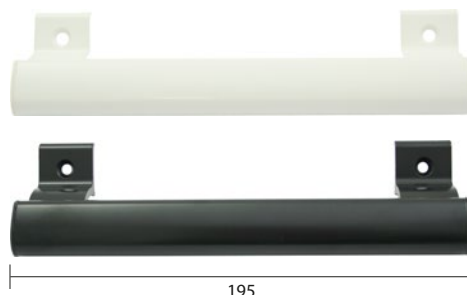

	biały	czarny
Netto	15,83	15,83
Brutto	19,47	19,47

Pochwyty jednostronny

NOWOŚĆ

Pochwyty dwustronny

NOWOŚĆ



Ø 25 225x200



Ø 32 332x300



INX POLER
Ø 25 225x200

INX
Ø 32 332x300

Netto	39,63	51,47
Brutto	48,75	63,31

Ø 32 300mm



UH-RZ-023

UH-RZ-020



INX
UH-RZ-020

INX POLER
UH-RZ-023

Netto	109,85	94,33
Brutto	135,11	116,02

Pochwyty dwustronny prostokątny



NOWOŚĆ



15x30x315x300 15x30x465x400 30x30x330x300 30x30x480x450

Netto	96,91	116,29	155,08	159,93
Brutto	119,20	143,04	190,75	196,71



Pochwyty dwustronny prosty Ø 32

NOWOŚĆ



INX INX/INX POLER INX POLER INX INX/INX POLER INX POLER

600x400 600x400 600x400 800x600 800x600 800x600

Netto	102,10	105,56	113,23	131,52	136,72	143,03
Brutto	125,58	129,84	139,27	161,77	168,16	175,93



Pochwyty dwustronny odgięty Ø 32

NOWOŚĆ



INX POLER INX INX INX POLER INX INX POLER INX INX POLER INX INX POLER

600x400 600x400 800x600 800x600 1000x800 1000x800 1500x1200 1500x1200 1800x1500 1800x1500

Netto	178,26	186,91	207,68	221,53	235,20	254,41	302,87	321,86	405,45	430,77
Brutto	219,25	229,90	255,45	272,48	289,30	312,93	372,54	395,89	498,71	529,84



Tuleje wentylacyjne okrągłe Ø 40 stalowe, grubość: 38-42 mm

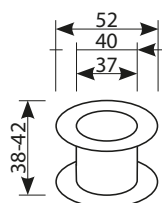

	M1	M2	M3	M4	M6	M9
Netto	10,62	10,62	10,62	10,62	10,62	10,62
Brutto	13,06	13,06	13,06	13,06	13,06	13,06

Tuleje wentylacyjne kwadratowe Ø 40 stalowe, grubość: 38-42 mm

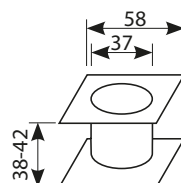

	M1	M2	M9
Netto	12,30	12,30	12,30
Brutto	15,13	15,13	15,13

Tuleje wentylacyjne Ø 40, grubość: 36-46 mm

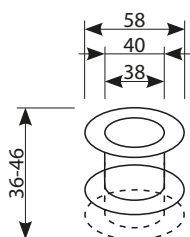

	INX	M1	M2	M3 MAT	M41	M6
Netto	21,71	22,82	22,82	22,82	22,82	22,82
Brutto	26,70	28,07	28,07	28,07	28,07	28,07

Tuleje wentylacyjne kwadratowe Ø 40, grubość: 36-46 mm

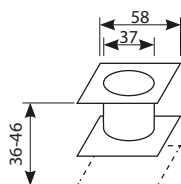

	INX	M1	M2	M3	M4	M41	M6	M91
Netto	23,77	31,53	31,53	31,53	31,53	31,53	29,95	31,53
Brutto	29,24	38,79	38,79	38,79	38,79	38,79	36,84	38,79

Tuleje wentylacyjne Ø 40, grubość: 30-40 mm

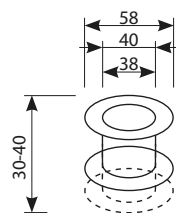

	INX	M1	M2	M3 MAT	M41	M6	M91
Netto	21,71	22,82	22,82	22,82	22,82	22,82	22,82
Brutto	26,70	28,07	28,07	28,07	28,07	28,07	28,07

Tuleje wentylacyjne kwadratowe Ø 40, grubość: 30-40 mm

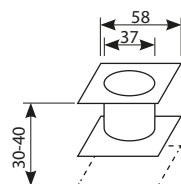

	INX	M6	M1	M2	M3 MAT	M41	M91
Netto	23,77	29,95	31,53	31,53	31,53	31,53	31,53
Brutto	29,24	36,84	38,79	38,79	38,79	38,79	38,79

Tuleje wentylacyjne Ø 22 mosiężne (szt.)

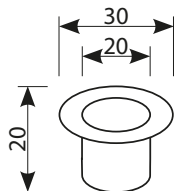

Netto	6,85	6,85	6,85	6,85
Brutto	8,42	8,42	8,42	8,42

Tuleje wentylacyjne Ø 30 mosiężne

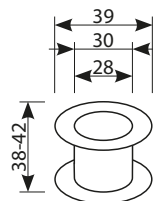

Netto	16,48	16,48	16,48	16,48	16,48
Brutto	20,27	20,27	20,27	20,27	20,27

Tuleje wentylacyjne Ø 35 mosiężne (szt.)

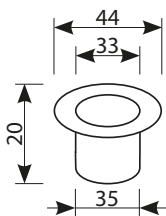

Netto	7,91	7,91	7,91	7,91	7,91
Brutto	9,73	9,73	9,73	9,73	9,73

Tuleje wentylacyjne Ø 40 mosiężne, grubość: 35-38 mm

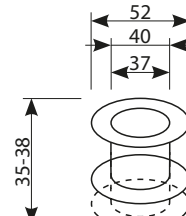

Netto	20,14	20,14	20,14	20,14	20,14
Brutto	24,77	24,77	24,77	24,77	24,77

Tuleje wentylacyjne Ø 40 mosiężne, grubość: 38-42 mm

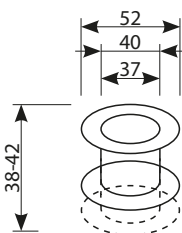

Netto	20,14	20,14	20,14	20,14	20,14
Brutto	24,77	24,77	24,77	24,77	24,77

Tuleje tworzywo

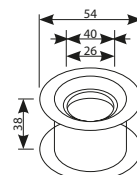

Netto	2,14	2,14	2,75	2,75	0,75
Brutto	2,63	2,63	3,38	3,38	0,92

Kratki wentylacyjne

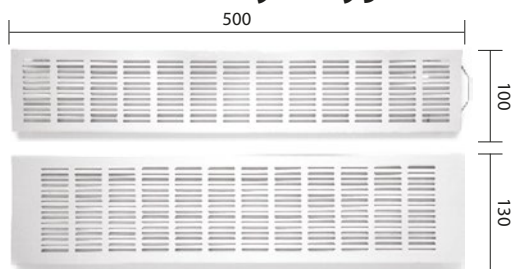

	100x500 (szt)	130x500 (szt)
Netto	43,48	46,63
Brutto	53,48	57,36

Oznaczenia WC



Samoprzylepne PCV



	grafit	oliwka	srebrny	złoty
Netto	8,31	8,31	8,31	8,31
Brutto	10,22	10,22	10,22	10,22

Oznaczenia WC

Samoprzylepne



	M1	M6
Netto	7,68	11,54
Brutto	9,44	14,19

Oznaczenie WC



	M1	M6
Netto	10,00	11,85
Brutto	12,30	14,57

Cyfry 5 cm: od 0 do 9

Samoprzylepne



	brąz	M4, M6, SN	M1 patyna biały złoty
Netto	3,08	3,58	4,62
Brutto	3,79	4,40	5,68

Cyfry 19 cm: od 0 do 9

Samoprzylepne PCV



	czarny
Netto	7,18
Brutto	8,83

Cyfry 10 cm: od 0 do 9

Samoprzylepne



	M1
Netto	16,15
Brutto	19,87

Cyfry 20 cm: od 0 do 9

Samoprzylepne



	M1
Netto	37,69
Brutto	46,36

Cyfry

Samoprzylepne PCV



	grafit	oliwka	srebrny	złoty
Netto	3,83	3,83	3,83	3,83
Brutto	4,71	4,71	4,71	4,71

Litery

Samoprzylepne PCV



	grafit	oliwka	srebro	złoty
Netto	3,68	3,68	3,68	3,68
Brutto	4,53	4,52	4,53	4,53

Myślniki

Samoprzylepne PCV



	grafit	oliwka	srebrny	złoty
Netto	3,68	3,68	3,68	3,68
Brutto	4,52	4,52	4,52	4,52

Zamek 3910

Zestaw na klucz BB

Zestaw na wkładkę PZ

Zestaw WC



Zestaw do drzwi przesuwnych zawiera:

- zamek hakowy,
- komplet szyldów,
- pochwyt.

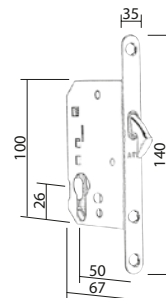

	Netto	Brutto
Zestaw na klucz BB	143,27	176,22
Zestaw na wkładkę PZ	143,27	176,22
Zestaw WC	143,27	176,22

Zamek 3911

Zestaw na klucz BB

Zestaw na wkładkę PZ

Zestaw WC



Zestaw do drzwi przesuwnych zawiera:

- zamek hakowy,
- komplet szyldów,
- pochwyt.

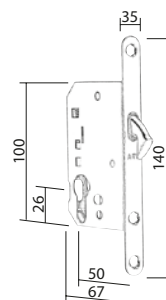

	Netto	Brutto
Zestaw na klucz BB	143,27	176,22
Zestaw na wkładkę PZ	143,27	176,22
Zestaw WC	143,27	176,22

Zamek HOMER

Zestaw na klucz BB

Zestaw WC

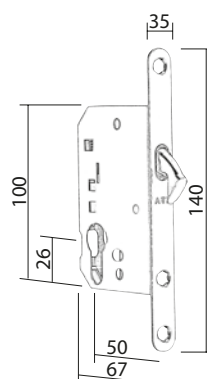

Zestaw do drzwi przesuwnych zawiera:

- zamek hakowy,
- komplet szyldów,
- pochwyt.

	Netto	Brutto
Zestaw na klucz BB	76,77	94,43
Zestaw WC	76,77	94,43

Jednostronne

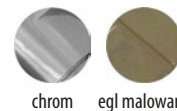

4240 Lewy / prawy

4242 Lewy / prawy

4261 Lewy / prawy

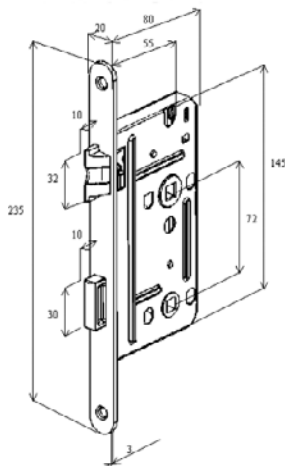
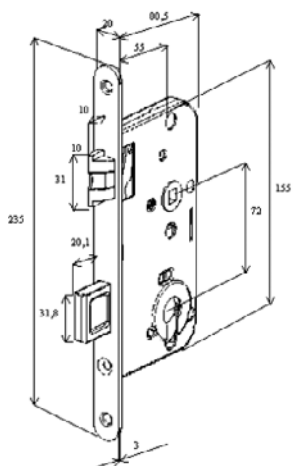
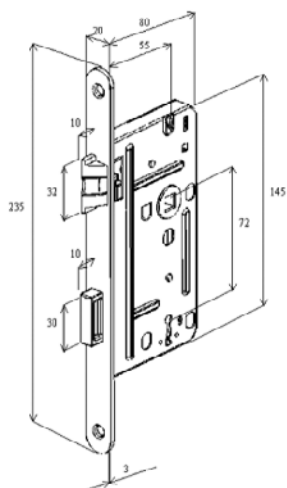

ASSA ABLOY

	chrom		egl malowany	
	netto	brutto	netto	brutto
4240 Lewy / prawy	18,05	22,20	14,26	17,54
4242 Lewy / prawy	18,05	22,20	14,26	17,54
4261 Lewy / prawy	18,05	22,20	14,26	17,54

Zamek BOX + blacha w komplecie

Klucz

Wkładka

WC

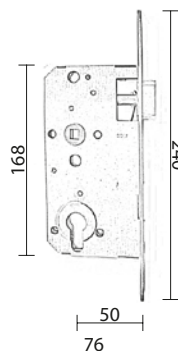

	ocynk biały		lakier piaskowy	
	netto	brutto	netto	brutto
Klucz	14,97	18,42	14,97	18,42
WC	13,77	16,94	13,77	16,94
Wkładka	13,77	16,94	13,77	16,94

- Rozstaw 72/50
- Rozstaw 72/60 L i P
- Rozstaw 90/50

Zamki Boda

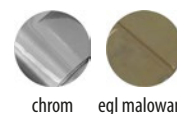

2014
Na klucz/WC

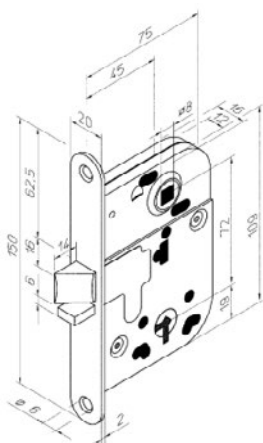

2018
Na wkładkę
bębenkową

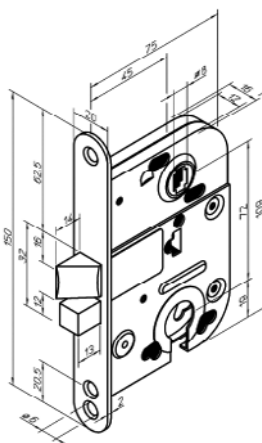

ASSA ABLOY

	Netto	Brutto
2014 Na klucz/WC	17,88	21,99
2018 Na wkładkę bębenkową	20,80	25,58

Blachy do zamków (patrz blachy zaczepowe Boda)

Blachy zaczepowe BODA

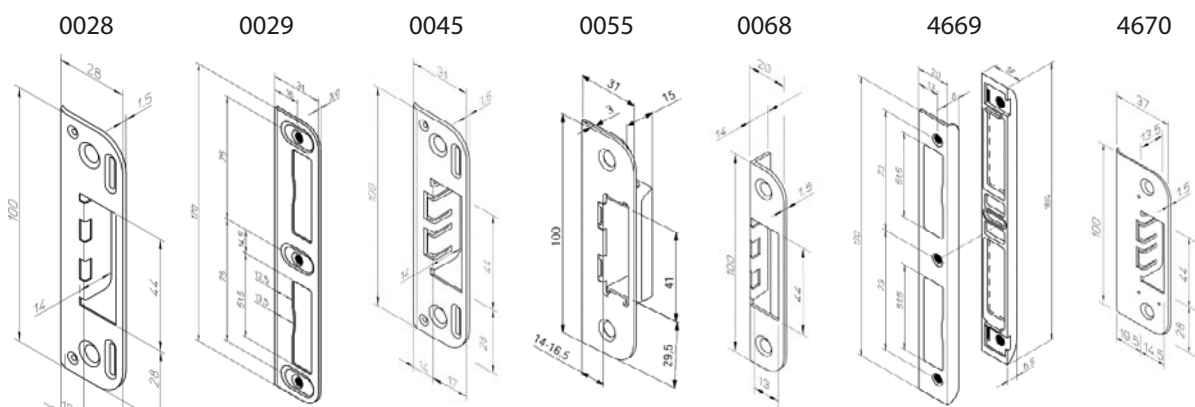
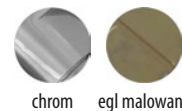

ASSA ABLOY

	Netto	Brutto
0028	1,88	2,31
0029	4,98	6,13
0045	1,65	2,02
0055	3,18	3,92
0068	1,65	2,02
4669	3,91	4,81
4670	3,05	3,75

Elektrozaczepy ocynk srebrny

Elektrozaczep R3 z blokadą



Zaczep kątowy długi



Zaczep płaski długi/krótki



Elektrozaczep R3 z blokadą i pamięcią



	Netto	Brutto
Elektrozaczep R3 z blokadą	67,43	82,94
Elektrozaczep R3 z blokadą i pamięcią	71,74	88,24
Zaczep kątowy długi	10,02	12,32
Zaczep płaski długi/krótki	8,91	10,96

Rygiel AFX



Zasuwka AFX

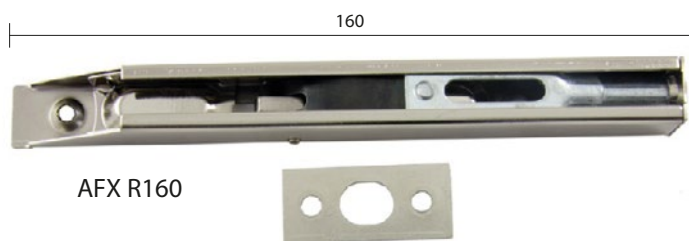

AFX R160

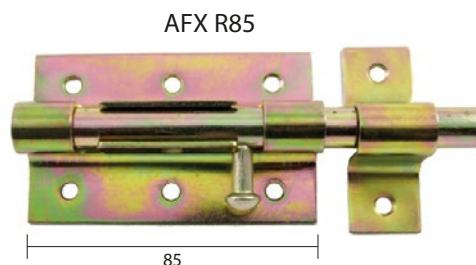

AFX R85



	Netto	Brutto
AFX R200	5,85	7,19
AFX R160	4,77	5,87

	Netto	Brutto
AFX R70	4,46	5,49
AFX R85	5,85	7,19
AFX R100	6,71	8,25
AFX R120	7,85	9,65
AFX R140	8,77	10,79



M1 M9

Zamki JANIA + blacha w komplecie



egl malowany

Klucz

Wkładka

WC



Rozstaw		Netto	Brutto
60/50	Klucz	14,62	17,98
	Wkładka	14,00	17,22
	WC	14,00	17,22
72/50	Klucz	16,40	20,17
	Wkładka	16,40	20,17
	WC	16,40	20,17
90/50	Klucz	16,40	20,17
	Wkładka	16,40	20,17
	WC	16,40	20,17

Zamki JANIA bramowe + blacha w komplecie



czarny

Klucz

Wkładka



Rozstaw		Netto	Brutto
90/22	Klucz	18,65	22,94
	Wkładka	16,95	20,85

Zamek oszczędnościowy



chrom



egl malowany



	Netto	Brutto
chrom	6,66	8,19
egl malowany	6,66	8,19

Zamek GERDA ZG



mosiądz antyczny



grafit



biały



nikiel perłowy



brąz

GERDA®
 drzwi antywłamaniowe i zamki

		Netto	Brutto
ZG 100	biały	58,46	71,91
	brąz	58,46	71,91
	grafit	58,46	71,91
ZG 200	brąz	78,46	96,51
	grafit	78,46	96,51
ZG 200s	mosiądz antyczny	84,62	104,08
	nikiel perłowy	84,62	104,08

Zamek GERDA ZN



biały



brąz



grafit

GERDA®
 drzwi antywłamaniowe i zamki

Netto	Brutto
53,85	66,24

Zamek GERDA ZX



brąz



grafit



czarny



satyna lakier

GERDA®
 drzwi antywłamaniowe i zamki

		Netto	Brutto
ZX 1000	brąz	213,85	263,04
	czarny	213,85	263,04
	grafit	213,85	263,04
	satyna lakier	213,85	263,04
ZX lewa	brąz	226,16	278,18
	czarny	226,16	278,18
	grafit	226,16	278,18
	srebro antyczne	226,16	278,18
	złoty słoneczny	226,16	278,18

Zamek magnetyczny HOMER

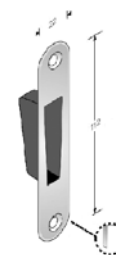
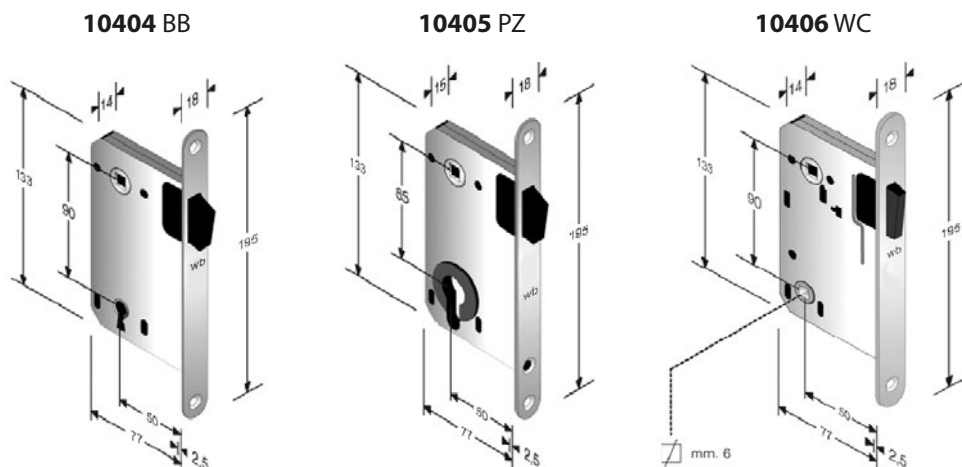

HOMER
JESTES U SIEBIE

nikiel lakierowany

	netto	brutto
10404 BB /90/	30,62	37,66
10405 PZ /85/	30,62	37,66
10406 WC /90/	30,62	37,66
Blacha regulowana	20,92	25,73

Zamek zawiera w komplecie blachę do ościeżnicy.

Zamki B FOUR

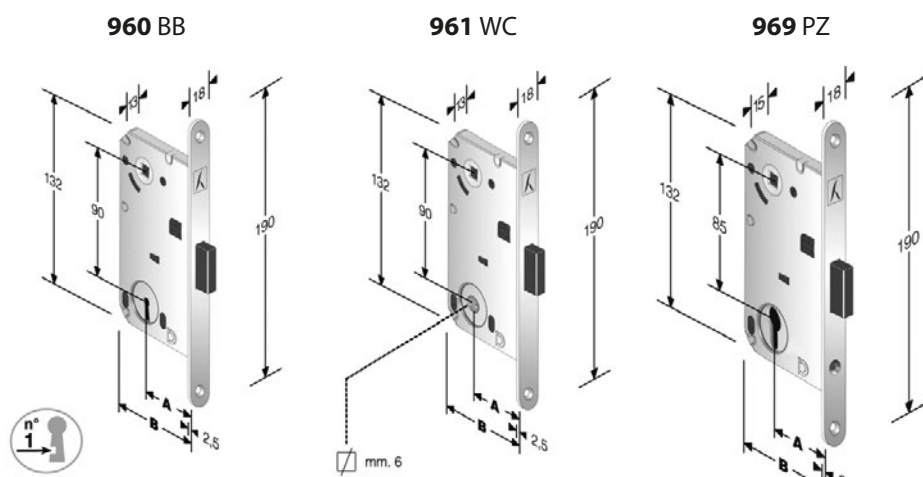

Bonaiti

chrom satynowany

	netto	brutto
960 BB /90/	49,69	61,12
961 WC /90/	51,85	63,78
969 PZ /85/	50,00	61,50
Blacha regulowana	20,92	25,73

Zamek zawiera w komplecie blachę do ościeżnicy.

Zamki B TWO

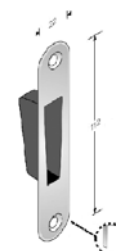
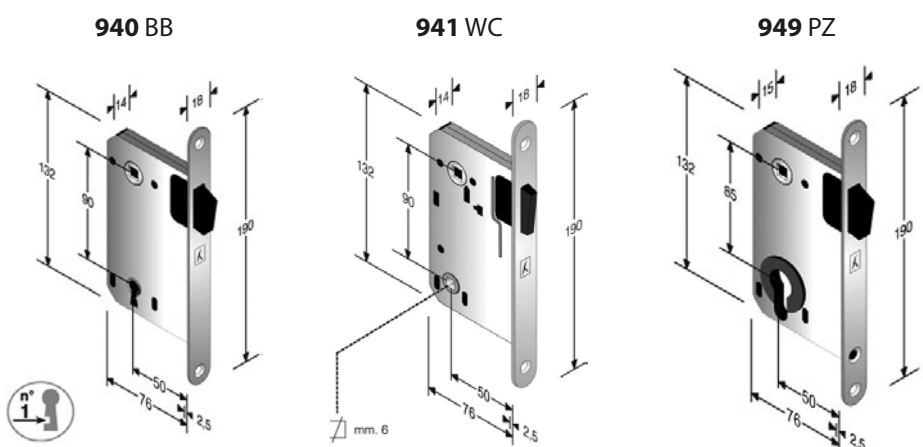

Bonaiti

chrom satynowany

	netto	brutto
940 BB	48,15	59,22
941 WC	51,23	63,01
949 PZ	55,23	67,93
Blacha regulowana	20,92	25,73

Zamek zawiera w komplecie blachę do ościeżnicy.

Odbojniki kuliste

Odbojnik kulisty



brąz grafiatto



chrom lakierowany



mosiądz lakierowany



mosiądz satynowany



nikiel lakierowany



Odbojnik kulisty samoprzylepny



brąz grafiatto



nikiel lakierowany

		Netto	Brutto
Odbojnik kulisty samoprzylepny	brąz grafiatto	5,70	7,02
	nikiel lakierowany	5,70	7,02
Odbojnik kulisty	brąz grafiatto	5,70	7,02
	chrom lakierowany	5,70	7,02
	mosiądz lakierowany	5,70	7,02
	mosiądz satynowany	5,70	7,02
	nikiel lakierowany	5,70	7,02

Odboje mosiężne

Podłoga niski



36



M1 M3 M6 M9

Netto Brutto
16,64 20,47

Odboje mosiężne

Podłoga



43



M1 M3 M6 M9

Netto Brutto
16,64 20,47

Odboje mosiężne

Ściana



73

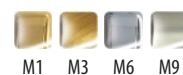

M1 M3 M6 M9

Netto Brutto
16,64 20,47

Odboje gumowe



74

maxi

90



49

medium

60



33

standard

28



	Netto	Brutto
standard	1,58	1,95
medium	7,13	8,77
maxi	24,56	30,21

Odboje magnetyczne

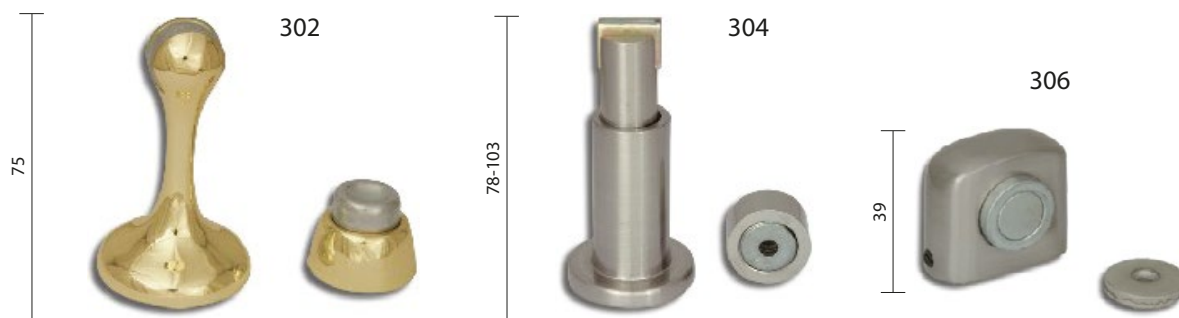

Netto	Brutto
15,05	18,52

Odboje tworzywo

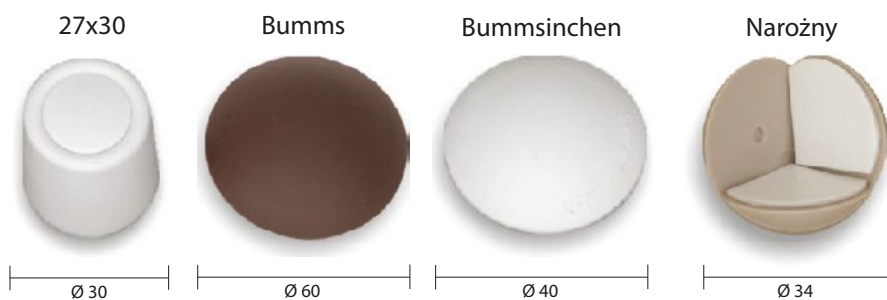

		Netto	Brutto
27x30	beż biały brąz przezroczysty	1,98	2,44
Bumms	beż biały brąz szary	3,17	3,90
Bummsinchen	beż biały brąz szary	2,85	3,51
Narożny	beż biały brąz	2,98	3,66

Odboje INX



	Netto	Brutto
1699	15,69	19,30
2199 przyklejany	16,16	19,88
2260	30,00	36,90

Odboje

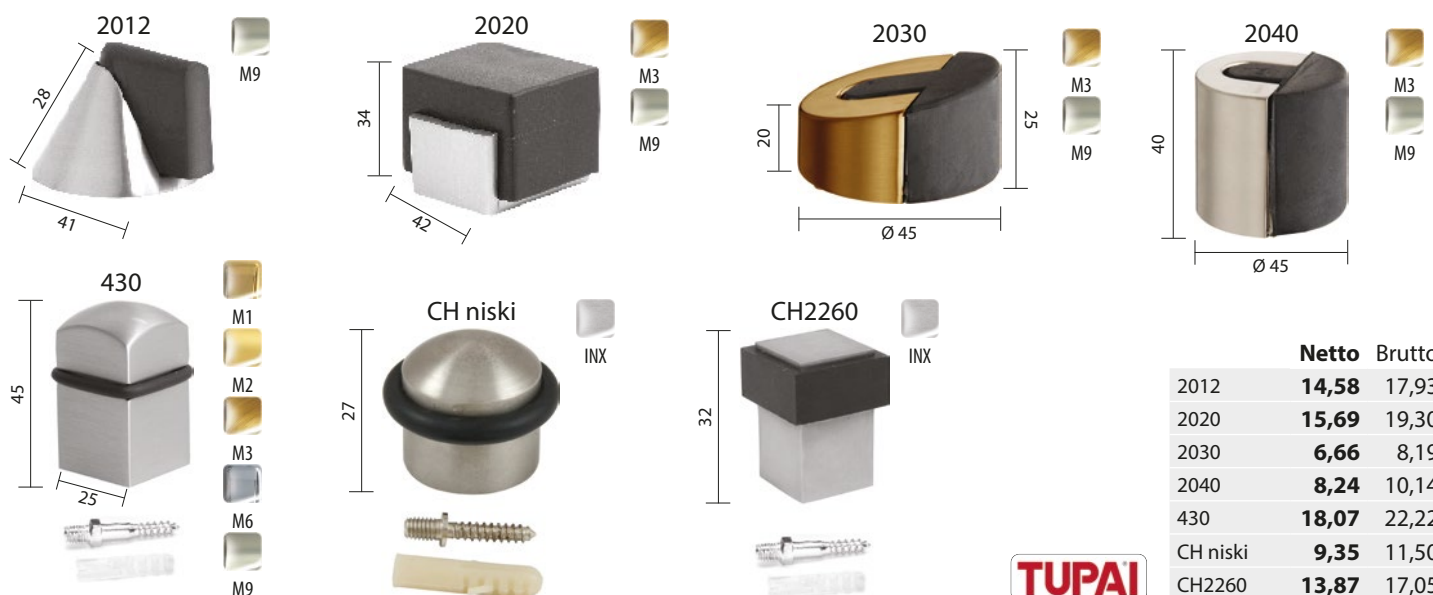

	Netto	Brutto
2012	14,58	17,93
2020	15,69	19,30
2030	6,66	8,19
2040	8,24	10,14
430	18,07	22,22
CH niski	9,35	11,50
CH2260	13,87	17,05



Stopery

Stoper 2080 klin (2 szt.)

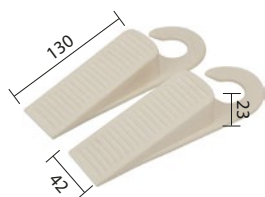

Stoper podłoga 2060

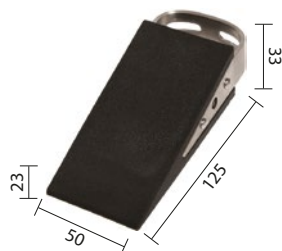

Stoper DB-04



Stoper DS-S03

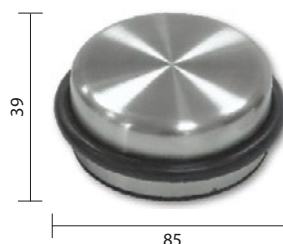

		Netto	Brutto
Stoper 2080 klin (2 szt.)	biały	4,60	5,65
Stoper podłoga 2060	czarny	14,10	17,35
Stoper DB-04	brąz grafiatto nikiel lakierowany	25,39	31,22
Stoper DS-S03	brąz grafiatto nikiel lakierowany	26,15	32,16

Zawias KUBICA



Zawias 1800



Zawias Invisible

przezroczysty



6200 SX/DX



6700 SX/DX



1825-16/76

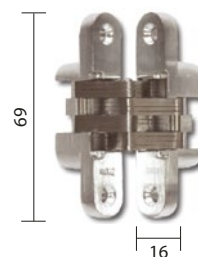

1826-19/90

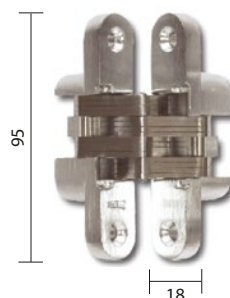

	Netto	Brutto
6200 SX/DX	105,38	129,62
6700 SX/DX	113,08	139,09

	Netto	Brutto
1800-16	12,20	15,01

	Netto	Brutto
1825-16/76	39,62	48,73
1826-19/90	50,55	62,18

Zawias 1722 INOX

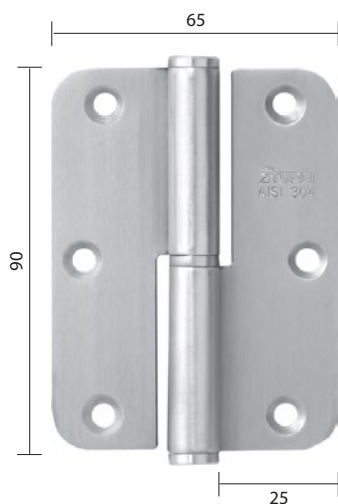

Prawy



Lewy



	Netto	Brutto
	17,69	21,76

Zawias mosiężny

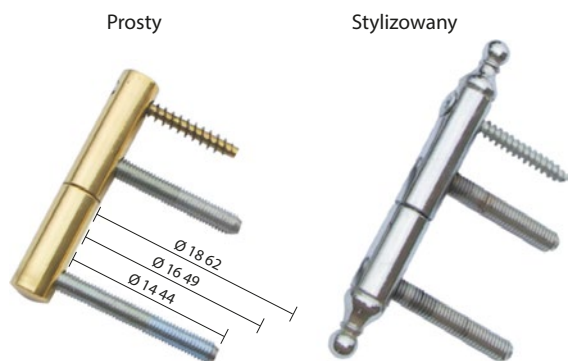

- Ø 14 prosty
14/91 mosiądz
- Ø 14 stylizowany
14/119 mosiądz
- Ø 16 prosty
16/107 mosiądz
- Ø 16 stylizowany
16/135 mosiądz
- Ø 18 prosty
18/114 mosiądz
- Ø 18 stylizowany
18/160 mosiądz

	M1 mosiądz lakierowany	M3 PAT patyna	M4 chrom satynowany	M6 chrom lakierowany
Ø 14 prosty	netto 18,70	18,70	18,70	18,70
brutto	23,00	23,00	23,00	23,00
Ø 14 stylizowany	netto 19,33	19,33	19,33	19,33
brutto	23,78	23,78	23,78	23,78
Ø 16 prosty	netto 21,55	21,55	21,55	21,55
brutto	26,51	26,51	26,51	26,51
Ø 16 stylizowany	netto 22,98	22,98	22,98	22,98
brutto	28,26	28,26	28,26	28,26
Ø 18 prosty	-	28,46	-	-
brutto	-	35,01	-	-
Ø 18 stylizowany	netto 29,27	29,27	29,27	28,46
brutto	36,00	36,00	36,00	35,01

Zawias regulowany



	ocynk srebrny	ocynk złoty
Ø 14 regulowany	netto 9,08	11,63
Exacta 495	brutto 11,17	14,30
Ø 16 regulowany	netto 12,31	12,31
Exacta 495	brutto 15,14	15,14
Ø 20 regulowany	netto 18,31	18,31
Exacta 495	brutto 22,52	22,52

Zawias regulowany

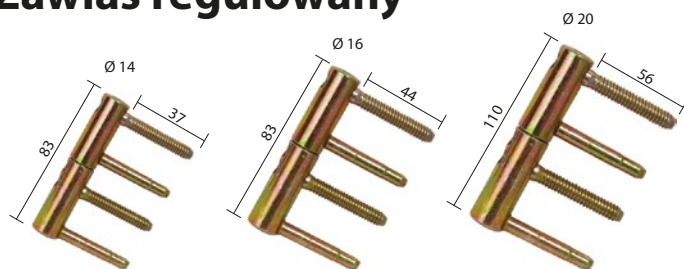

	ocynk złoty
Ø 14 regulowany	netto 9,51
	brutto 11,69
Ø 16 regulowany	netto 11,55
	brutto 14,21
Ø 20 regulowany	netto 16,07
	brutto 19,76

Zawias regulowany

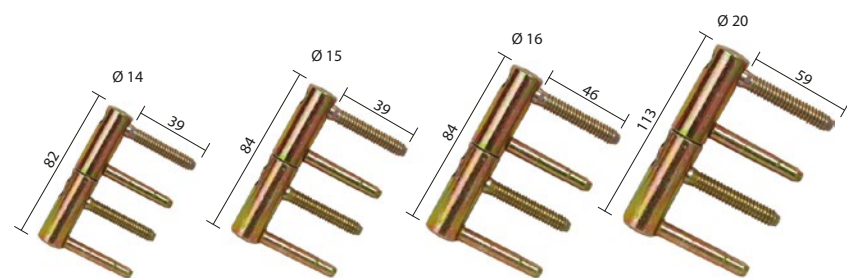

	ocynk złoty
Ø 14 regulowany	netto 8,29
	brutto 10,19
Ø 15 regulowany	netto 12,84
	brutto 15,79
Ø 16 regulowany	netto 10,76
	brutto 13,23
Ø 20 regulowany	netto 16,26
	brutto 20,00

Zawias regulowany

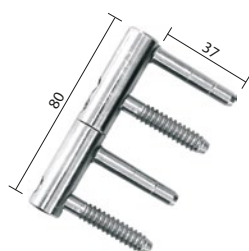

	ocynk złoty	ocynk srebrny
Ø 14 regulowany	netto 6,97	6,97
14/80 stal	brutto 8,58	8,58

Zawias Invisible 830

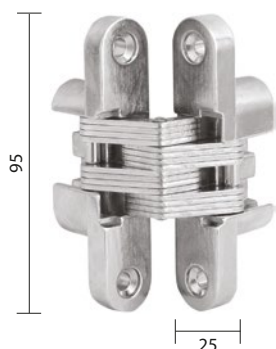

Zawias Invisible



Zawiasy CAB-R



	Netto	Brutto
830-19/95	64,97	79,91

	Netto	Brutto
SYMBIO 22 uniwersalny	101,72	125,12

	Netto	Brutto
Zawias CAB-R (kpl.)	129,15	158,85
Osłonka (szt.)	12,00	14,76

Osłonki zawiasu 13,5 x 80, tworzywo



biały	M3 PAT	M1	M2	M4	M6	M9
1,00	1,00	1,91	1,91	1,91	1,91	1,91
1,23	1,23	2,35	2,35	2,35	2,35	2,35

Osłonki zawiasu, aluminium



	M1	M3	M4	M6	M9
Ø 14x80 Aluminium (kpl.)	netto 3,54	3,54	3,54	3,54	3,54
	brutto 4,35	4,35	4,35	4,35	4,35
Ø 15x82 Aluminium (kpl.)	netto 3,88	3,88	3,88	3,88	3,88
	brutto 4,77	4,77	4,77	4,77	4,77
Ø 16x82 Aluminium (kpl.)	netto 4,20	4,20	4,20	4,20	4,20
	brutto 5,17	5,17	5,17	5,17	5,17
Ø 20x105 Aluminium (kpl.)	netto 5,23	5,23	5,23	5,23	5,23
	brutto 6,43	6,43	6,43	6,43	6,43

Wizjery

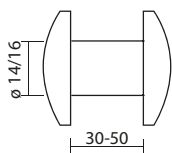

		brąz grafiatto	nikiel lakierowany
Wizjer Ø 14 30/50/160	netto	6,18	6,18
	brutto	7,60	7,60
Wizjer Ø 16 30/50/180	netto	7,76	7,76
	brutto	9,55	9,55



	Netto	Brutto
LCD	290,00	356,70

Wizjery

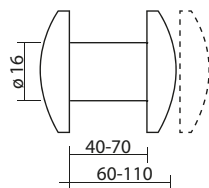
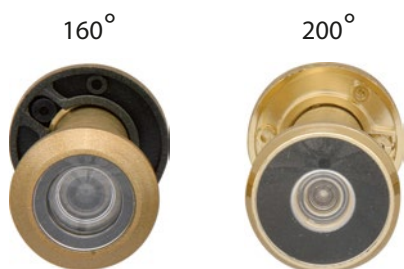

		M1	M3	M6	M9	M50
Wizjer Ø 16 40/70/160	netto	13,23	13,23	13,23	-	-
	brutto	16,27	16,27	16,27	-	-
Wizjer Ø 16 40/70/200	netto	18,31	18,31	18,31	18,31	-
	brutto	22,52	22,52	22,52	22,52	-
Wizjer Ø 16 60/110/200	netto	18,31	18,31	18,31	-	-
	brutto	22,52	22,52	22,52	-	-
Wizjer Ø 16 60/92/160	netto	-	-	-	-	18,31
	brutto	-	-	-	-	22,52

Akcesoria



Zestaw montażowy klamki



	mosiądz lakierowany		brąz grafiatto		nikiel lakierowany	
	netto	brutto	netto	brutto	netto	brutto
120 mm	-	-	5,85	7,19	5,85	7,19
140 mm	5,85	7,19	5,85	7,19	5,85	7,19

Reduktory średnicy pręta WC



	Netto	Brutto
4/5	1,23	1,51
4/6	1,23	1,51
4/8	1,23	1,51
8/9	1,23	1,51
8/10	1,23	1,51

Pręt kwadratowy



	Netto	Brutto
4x70	1,29	1,59
8x100	2,92	3,60
8x120	3,08	3,79
8x140	3,08	3,79

Śruby przelotowe



	Netto	Brutto
Ø 7,5 (2 szt.)	3,01	3,70

Wkręty do klamek



	Netto	Brutto
3,5x20 (4 szt.)	1,58	1,95

Śrubka imbusowa

stalowa



	Netto	Brutto
Ø 5 lub Ø 6	0,77	0,95

Szyld owalny Plus

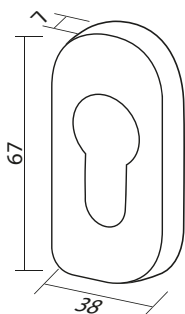
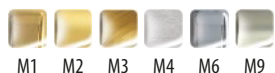

	Netto	Brutto
Owalny Plus (kpl.)	13,54	16,65

Szyld 10710

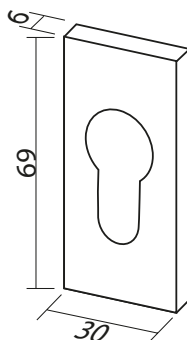

	Netto	Brutto
Nasuwany 10710 (szt.)	27,03	33,25

Szyld 0006 Plus

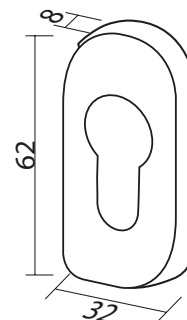
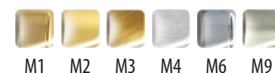

	Netto	Brutto
Owalny 0006 plus (kpl.)	11,85	14,57

TS 1500

szyna ślizgowa

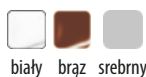

GEZE

	Netto	Brutto
Szyna ślizgowa TS 1500	90,39	111,18

TS 4000/2000

szyna ślizgowa

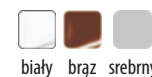

GEZE

	Netto	Brutto
Szyna ślizgowa TS 4000/2000	118,34	145,56

TS 5000/3000 V

szyna ślizgowa



GEZE

	Netto	Brutto
Szyna ślizgowa TS 5000/3000 V	91,16	112,12

TS 3000 V

z szyną

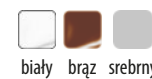

GEZE

	Netto	Brutto
TS 3000 V z szyną	415,80	511,43

TS 1000

z ramieniem

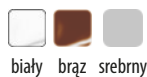

biały brąz srebrny



	Netto	Brutto
TS 1000 z ramieniem	115,52	142,09

TS 1500

z ramieniem



biały brąz srebrny



	Netto	Brutto
TS 1500 z ramieniem	142,48	175,25

TS 2000 V-BC

z ramieniem

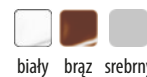

biały brąz srebrny



	Netto	Brutto
TS 2000 VBC z ramieniem	203,12	249,84

TS 2000 V

z ramieniem



biały brąz srebrny



	Netto	Brutto
TS 2000 V z ramieniem	162,70	200,12

TS 1500

z ramieniem z blokadą



biały brąz srebrny



	Netto	Brutto
TS 1500 z ramieniem z blokadą	217,59	267,63

TS 2000

z ramieniem z blokadą

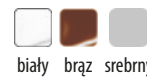

biały brąz srebrny



	Netto	Brutto
TS 2000 z ramieniem z blokadą	233,99	287,81

Kołatka CH Barocco



brąz grafiatto



czarny złoty

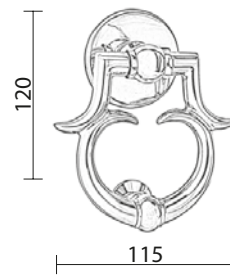

	Netto	Brutto
brąz grafiatto	33,85	41,63
czarny złoty	36,92	45,42

Kołatka CH Tondo



brąz grafiatto



czarny złoty

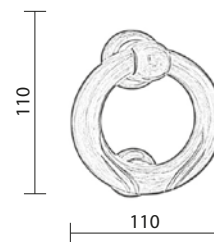

	Netto	Brutto
brąz grafiatto	33,85	41,63
czarny złoty	36,92	45,42

Kołatka Victorian



mosiądz lakierowany



brąz grafiatto



chrom lakierowany

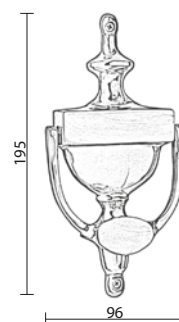

	Netto	Brutto
mosiądz lakierowany	36,82	45,29
brąz grafiatto	36,82	45,29
chrom lakierowany	46,85	57,63

Wkładki DMO

Dwustronna



M1	netto	brutto
DMO 26/36	14,80	18,20
DMO 31/31	14,34	17,64
DMO 31/36	14,62	17,98
DMO 31/41	15,57	19,15
DMO 31/46	16,67	20,50
DMO 31/51	19,79	24,34
DMO 31/56	19,79	24,34
DMO 35/65	29,59	36,39
DMO 36/36	16,18	19,90
DMO 36/41	17,18	21,13
DMO 36/46	22,31	27,44
DMO 36/51	20,60	25,34
DMO 41/41	22,77	28,01
DMO 41/46	24,17	29,72
DMO 41/51	25,15	30,93
DMO 41/56	27,84	34,25
DMO 46/46	25,35	31,19

M6	netto	brutto
DMO 26/36	15,70	19,31
DMO 31/31	14,62	17,98
DMO 31/36	14,83	18,24
DMO 31/41	16,67	20,50
DMO 31/46	17,45	21,46
DMO 31/51	20,96	25,79
DMO 31/56	20,79	25,57
DMO 35/65	30,71	37,77
DMO 36/36	17,03	20,95
DMO 36/41	17,97	22,10
DMO 36/46	23,33	28,69
DMO 36/51	21,38	26,29
DMO 41/41	22,07	27,15
DMO 41/46	24,75	30,45
DMO 41/51	26,15	32,16
DMO 41/56	29,01	35,69
DMO 46/46	26,15	32,16

Wkładki DMO

Z gałką



M1	netto	brutto
DMO 26/36G	24,23	29,80
DMO 31/31G	24,23	29,80
DMO 31/36G	25,18	30,97
DMO 31/41G	25,77	31,70
DMO 31/46G	26,95	33,15
DMO 31/51G	28,71	35,32
DMO 31/56G	29,16	35,86
DMO 36/31G	25,94	31,91
DMO 36/36G	26,76	32,92
DMO 36/41G	27,76	34,15
DMO 36/46G	29,36	36,12
DMO 36/51G	29,92	36,80
DMO 41/31G	26,76	32,92
DMO 41/36G	27,53	33,86
DMO 41/41G	28,95	35,61
DMO 41/46G	30,16	37,09
DMO 41/51G	31,09	38,24
DMO 41/56G	33,50	41,20
DMO 46/31G	28,56	35,12
DMO 46/36G	27,97	34,40
DMO 46/41G	30,16	37,09
DMO 46/46G	31,34	38,55
DMO 51/31G	28,90	35,55
DMO 51/36G	29,92	36,80
DMO 51/41G	31,34	38,55
DMO 56/31G	29,16	35,86
DMO 56/41G	33,50	41,20

M6	netto	brutto
DMO 26/36G	25,39	31,23
DMO 31/31G	25,39	31,23
DMO 31/36G	25,98	31,96
DMO 31/41G	26,72	32,87
DMO 31/46G	27,91	34,33
DMO 31/51G	29,71	36,55
DMO 31/56G	29,55	36,35
DMO 36/31G	26,76	32,92
DMO 36/36G	27,76	34,15
DMO 36/41G	28,52	35,08
DMO 36/46G	30,98	38,11
DMO 36/51G	30,50	37,52
DMO 41/31G	27,53	33,86
DMO 41/36G	28,75	35,36
DMO 41/41G	28,14	34,62
DMO 41/46G	30,74	37,81
DMO 41/51G	31,95	39,29
DMO 41/56G	34,69	42,67
DMO 46/31G	29,16	35,86
DMO 46/36G	30,98	38,11
DMO 46/41G	30,95	38,07
DMO 46/46G	31,95	39,29
DMO 51/31G	29,32	36,06
DMO 51/36G	30,50	37,52
DMO 51/41G	31,68	38,96
DMO 56/31G	29,32	36,06
DMO 56/41G	34,69	42,67

Wkładki DMO

Zestawy wkładek jednakowo kodowanych (3 klucze)



M1	netto	brutto
DMO 26/36-26/36G kpl. (3kl.)	56,84	69,91
DMO 31/31-31/31G kpl. (3kl.)	56,84	69,91
DMO 31/36-31/36G kpl. (3kl.)	58,36	71,79
DMO 31/36-36/31G kpl. (3kl.)	58,36	71,79
DMO 31/41-31/41G kpl. (3kl.)	60,26	74,13
DMO 31/41-41/31G kpl. (3kl.)	60,26	74,13
DMO 31/46-31/46G kpl. (3kl.)	61,79	76,00
DMO 31/46-46/31G kpl. (3kl.)	61,79	76,00
DMO 31/51-31/51G kpl. (3kl.)	65,59	80,67
DMO 31/51-51/31G kpl. (3kl.)	65,59	80,67
DMO 31/56-31/56G kpl. (3kl.)	42,47	52,24
DMO 31/56-56/31G kpl. (3kl.)	42,47	52,24
DMO 36/36-36/36G kpl. (3kl.)	59,87	73,64
DMO 36/41-36/41G kpl. (3kl.)	61,79	76,00
DMO 36/41-41/36G kpl. (3kl.)	61,79	76,00
DMO 36/46-36/46G kpl. (3kl.)	83,37	102,54
DMO 36/51-36/51G kpl. (3kl.)	67,49	83,01
DMO 36/51-51/36G kpl. (3kl.)	68,82	84,65
DMO 41/41-41/41G kpl. (3kl.)	68,25	83,95
DMO 41/46-41/46G kpl. (3kl.)	70,72	86,99
DMO 41/46-46/41G kpl. (3kl.)	70,72	86,99

M6	netto	brutto
DMO 26/36-26/36G kpl. (3kl.)	58,17	71,55
DMO 31/31-31/31G kpl. (3kl.)	58,36	71,79
DMO 31/36-31/36G kpl. (3kl.)	60,22	74,07
DMO 31/36-36/31G kpl. (3kl.)	60,22	74,07
DMO 31/41-31/41G kpl. (3kl.)	61,79	76,00
DMO 31/41-41/31G kpl. (3kl.)	61,79	76,00
DMO 31/46-31/46G kpl. (3kl.)	61,79	76,00
DMO 31/46-46/31G kpl. (3kl.)	63,50	78,10
DMO 31/51-31/51G kpl. (3kl.)	68,16	83,83
DMO 31/51-51/31G kpl. (3kl.)	68,16	83,83
DMO 31/56-31/56G kpl. (3kl.)	42,47	52,24
DMO 31/56-56/31G kpl. (3kl.)	42,47	52,24
DMO 36/36-36/36G kpl. (3kl.)	61,79	76,00
DMO 36/41-36/41G kpl. (3kl.)	63,50	78,10
DMO 36/41-41/36G kpl. (3kl.)	63,50	78,10
DMO 36/46-36/46G kpl. (3kl.)	83,37	102,54
DMO 36/51-36/51G kpl. (3kl.)	68,82	84,65
DMO 36/51-51/36G kpl. (3kl.)	68,82	84,65
DMO 41/41-41/41G kpl. (3kl.)	69,38	85,33
DMO 41/46-41/46G kpl. (3kl.)	71,85	88,37
DMO 41/46-46/41G kpl. (3kl.)	71,85	88,37

Wkładki DMO ECO

Dwustronna



M1 M6



	M1		M6	
	netto	brutto	netto	brutto
DMO ECO 26/36	14,80	18,20	15,70	19,31
DMO ECO 31/31	14,34	17,64	14,62	17,98
DMO ECO 31/36	14,62	17,98	15,57	19,15
DMO ECO 31/41	15,57	19,15	16,67	20,50

Wkładki DMO ECO

Z gałką



M1 M6



	M1		M6	
	netto	brutto	netto	brutto
DMO ECO 31/31G	24,23	29,80	25,39	31,23
DMO ECO 31/36G	25,18	30,97	25,98	31,96
DMO ECO 31/41G	25,77	31,70	26,72	32,87
DMO ECO 36/31G	25,18	30,97	25,98	31,96
DMO ECO 41/31G	25,98	31,96	26,72	32,87

Wkładka GERDA WKE1



M1 M9



	Z gałką			
	M1		M9	
	netto	brutto	netto	brutto
WKE1 30/30G	30,31	37,28	33,39	41,06
WKE1 30/35G	33,08	40,69	34,62	42,58
WKE1 30/40G	34,31	42,20	35,69	43,90
WKE1 35/30G	33,08	40,69	34,62	42,58
WKE1 36/28G	31,54	38,79	34,77	42,77
WKE1 40/30G	34,31	42,20	35,69	43,90

	Dwustronna			
	M1		M9	
	netto	brutto	netto	brutto
WKE1 28/36	22,46	27,63	25,23	31,03
WKE1 30/30	21,08	25,93	23,85	29,33
WKE1 30/35	24,15	29,71	27,23	33,49
WKE1 30/40	29,23	35,95	29,23	35,95
WKE1 30/45	28,77	35,39	31,85	39,17
WKE1 30/50	30,62	37,66	33,69	41,44
WKE1 35/35	26,92	33,12	30,15	37,09
WKE1 35/40			32,15	39,55
WKE1 35/50	33,23	40,87		
WKE1 35/55	35,23	43,33	35,23	43,33
WKE1 40/50	35,23	43,33	38,17	46,95

ECOLINE K5

- cylinder mosiężny
- profil aluminiowy
- kolory: mosiądz satyna, nikiel satyna
- 5 kluczy w komplecie
- klucz płaski nawiercany



JESTES U SIEBIE

	Dwustronna				Z gałką				
	M2		M9		M2		M9		
	netto	brutto	netto	brutto	netto	brutto	netto	brutto	
31/31	12,15	14,94	12,15	14,94	31/31G	15,60	19,19	15,60	19,19
31/36	12,15	14,94	12,15	14,94	31/41G	17,91	22,03	17,91	22,03
31/41	14,31	17,60	14,31	17,60	36/31G	16,71	20,55	16,71	20,55
					41/31G	17,91	22,03	17,91	22,03

Wkładki bębnowe



5 kluczy w komplecie

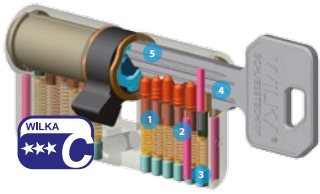

1. Stalowe i mosiężne kołki bębna i korpusu utwardzone powłoką niklową
2. Kołki grzybkowe jako zabezpieczenie „antypikowe”
3. Stalowe hartowane kołki w korpusie chroniące przed przewierceniem
4. Stalowe hartowane kołki w bębnie chroniące przed przewierceniem
5. Specjalny chroniony profil klucza

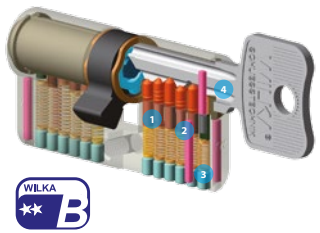

1. Stalowe i mosiężne kołki bębna i korpusu utwardzone powłoką niklową
2. Kołki grzybkowe jako zabezpieczenie „antypikowe”
3. Stalowe hartowane kołki w korpusie chroniące przed przewierceniem
4. Stalowe hartowane kołki w bębnie chroniące przed przewierceniem

Dwustronna

Typ/ Wymiar	Klasa B		Klasa C	
	netto	brutto	netto	brutto
1481 26/26	67,71	83,29	107,61	132,36
1481 26/30	67,71	83,29	107,61	132,36
1481 26/35	72,62	89,32	112,84	138,80
1481 26/40	77,53	95,36	117,87	144,98
1481 26/45	82,43	101,39	123,10	151,42
1481 26/50	87,34	107,43	128,34	157,85
1481 26/55	96,17	118,29	133,57	164,29
1400 30/30	67,71	83,29	107,61	132,36
1400 30/35	72,62	89,32	112,84	138,80
1400 30/40	77,53	95,36	117,87	144,98
1400 30/45	82,43	101,39	123,10	151,42
1400 30/50	87,34	107,43	128,34	157,85
1400 30/55	96,17	118,29	133,57	164,29
1400 30/60	101,28	124,57	138,80	170,73
1400 30/65	105,99	130,36	144,04	177,17
1400 30/70	111,09	136,64	149,27	183,61
1400 35/35	77,53	95,36	117,87	144,98
1400 35/40	82,43	101,39	123,10	151,42
1400 35/45	87,34	107,43	128,34	157,85
1400 35/50	96,17	118,29	133,57	164,29
1400 35/55	101,28	124,57	138,80	170,73
1400 35/60	105,99	130,36	144,04	177,17
1400 35/65	111,09	136,64	149,27	183,61
1400 35/70	115,80	142,44	154,51	190,04
1400 40/40	87,34	107,43	128,34	157,85
1400 40/45	96,17	118,29	133,57	164,29
1400 40/50	101,28	124,57	138,80	170,73
1400 40/55	105,99	130,36	144,04	177,17
1400 40/60	111,09	136,64	149,27	183,61
1400 40/65	115,80	142,44	154,51	190,04
1400 40/70	120,90	148,71	159,74	196,48
1400 45/45	111,88	137,61	138,80	170,73
1400 45/50	105,99	130,36	144,04	177,17
1400 45/55	111,09	136,64	149,27	183,61
1400 45/60	115,80	142,44	154,51	190,04
1400 45/65	120,90	148,71	159,74	196,48
1400 45/70	135,43	166,58	175,44	215,79
1400 50/50	111,09	136,64	149,27	183,61
1400 50/55	115,80	142,44	154,51	190,04
1400 50/60	120,90	148,71	159,74	196,48
1400 50/65	135,43	166,58	175,44	215,79
1400 55/55	120,90	148,71	159,74	196,48
1400 55/60	135,43	166,58	175,44	215,79
1400 55/65	150,35	184,93	191,14	235,11
1400 60/60	150,35	184,93	191,14	235,11
1400 60/65	164,87	202,79	206,85	254,42

Typ/ Wymiar	Z gałką			
	Klasa B		Klasa C	
	netto	brutto	netto	brutto
1484 26/26	96,23	118,36	124,71	153,40
1484 26/30	96,23	118,36	124,71	153,40
1484 26/35	101,11	124,36	129,92	159,80
1484 26/40	105,99	130,37	135,12	166,20
1484 26/45	110,87	136,37	140,33	172,60
1484 26/50	115,75	142,37	145,53	179,01
1484 26/55	124,53	153,17	150,74	185,41
1484 30/26	96,23	118,36	124,71	153,40
1405 30/30	96,23	118,36	124,71	153,40
1405 30/35	101,11	124,36	129,92	159,80
1405 30/40	105,99	130,37	135,12	166,20
1405 30/45	110,87	136,37	140,33	172,60
1405 30/50	115,75	142,37	145,53	179,01
1405 30/55	124,53	153,17	150,74	185,41
1405 30/60	129,61	159,42	155,94	191,81
1405 30/65	134,29	165,18	161,15	198,21
1405 30/70	139,17	171,18	166,35	204,62
1484 35/26	101,11	124,36	129,92	159,80
1405 35/30	101,11	124,36	129,92	159,80
1405 35/40	110,87	136,37	140,33	172,60
1405 35/45	115,75	142,37	145,53	179,01
1405 35/50	124,53	153,17	150,74	185,41
1405 35/55	129,61	159,42	155,94	191,81
1405 35/60	134,29	165,18	161,15	198,21
1405 35/65	139,17	171,18	166,35	204,62
1405 35/70	144,05	177,18	171,56	211,02
1484 40/26	105,99	130,37	135,12	166,20
1405 40/30	105,99	130,37	135,12	166,20
1405 40/35	110,87	136,37	140,33	172,60
1405 40/40	115,75	142,37	145,53	179,01
1405 40/45	124,53	153,17	150,74	185,41
1405 40/50	129,61	159,42	155,94	191,81
1405 40/55	134,29	165,18	161,15	198,21
1405 40/60	139,17	171,18	166,35	204,62
1405 40/65	144,05	177,18	171,56	211,02
1405 40/70	148,93	183,18	176,76	217,42
1484 45/26	110,87	136,37	140,33	172,60
1405 45/30	110,87	136,37	140,33	172,60
1405 45/35	115,75	142,37	145,53	179,01
1405 45/40	124,53	153,17	150,74	185,41
1405 45/45	129,61	159,42	155,94	191,81
1405 45/50	134,29	165,18	161,15	198,21
1405 45/55	139,17	171,18	166,35	204,62
1405 45/60	144,05	177,18	171,56	211,02
1405 45/65	148,93	183,18	176,76	217,42
1405 45/70	163,57	201,19	192,38	236,63
1484 50/26	115,75	142,37	145,53	179,01
1405 50/30	115,75	142,37	145,53	179,01
1405 50/35	124,53	153,17	150,74	185,41
1405 50/40	129,61	159,42	155,94	191,81
1405 50/45	134,29	165,18	161,15	198,21
1405 50/50	139,17	171,18	166,35	204,62
1405 50/55	144,05	177,18	171,56	211,02
1405 50/60	148,93	183,18	176,76	217,42
1405 50/65	163,57	201,19	192,38	236,63
1484 55/26	124,53	153,17	150,74	185,41
1405 55/30	124,53	153,17	150,74	185,41
1405 55/35	129,61	159,42	155,94	191,81
1405 55/40	134,29	165,18	161,15	198,21
1405 55/45	139,17	171,18	166,35	204,62
1405 55/50	144,05	177,18	171,56	211,02
1405 55/55	148,93	183,18	176,76	217,42
1405 55/60	163,57	201,19	192,38	236,63
1405 55/65	178,21	219,20	207,79	255,58
1405 60/30	129,61	159,42	155,94	191,81
1405 60/35	134,29	165,18	161,15	198,21
1405 60/40	139,17	171,18	166,35	204,62
1405 60/45	144,05	177,18	171,56	211,02
1405 60/50	148,93	183,18	176,76	217,42
1405 60/55	163,57	201,19	192,38	236,63
1405 60/60	178,21	219,20	207,79	255,58
1405 60/65	192,85	237,20	223,40	274,78
1405 65/30	134,29	165,18	161,15	198,21
1405 65/35	139,17	171,18	166,35	204,62
1405 65/40	144,05	177,18	171,56	211,02
1405 65/45	148,93	183,18	176,76	217,42
1405 65/50	163,57	201,19	192,38	236,63
1405 65/55	178,21	219,20	207,79	255,58
1405 70/30	139,17	171,18	166,35	204,62
1405 70/35	144,05	177,18	171,56	211,02
1405 70/40	148,93	183,18	176,76	217,42
1405 70/45	163,57	201,19	192,38	236,63

Zestaw wkładek jednakowo kodowanych

WILKA®
SCHLIESSTECHNIK

6 kluczy w komplecie

Jeden klucz zamiast pęku kluczy

Identyczne kodowanie zamknięć to rozwiązanie, które pozwala na otwieranie wszystkich wkładek, kłódek, zamków za pomocą jednego klucza. Sprawdza się ono w domu, sklepie lub magazynie i daje możliwość otwierania jednym kluczem wszystkich drzwi, bram, furtek lub skrzynek.

Wyższy poziom zabezpieczenia obiektu

W zależności od wymagań, w ramach identycznego kodowania, można zamówić wkładki atestowane w różnych klasach zabezpieczenia - A, B, C, C Premium.

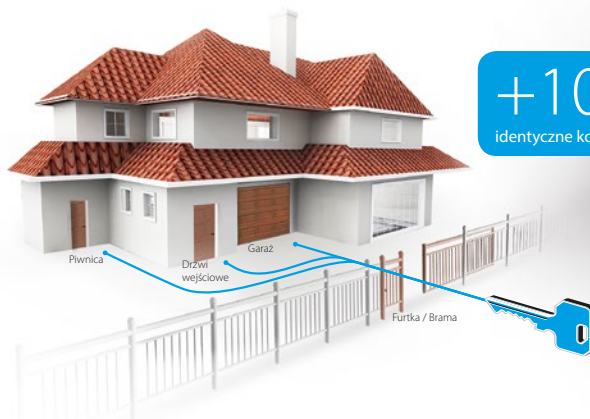

Komplet wkładek standard

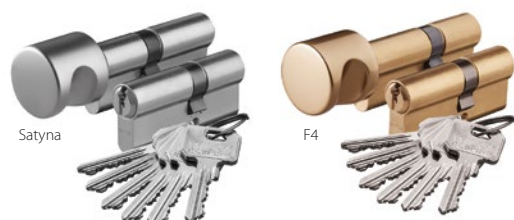

Kolorystyka gałek na zamówienie



Typ/ Wymiar	Komplety wkładek			
	Klasa B		Klasa C	
	netto	brutto	netto	brutto
1484 26/35 + 1481 26/35	144,14	177,29	178,79	219,91
1484 26/40 + 1481 26/40	152,68	187,80	186,39	229,26
1484 26/45 + 1481 26/45	161,19	198,26	193,99	238,61
1484 26/50 + 1481 26/50	169,73	208,76	201,59	247,95
1484 26/55 + 1481 26/55	178,25	219,25	209,19	257,30
1484 35/26 + 1481 26/35	144,14	177,29	178,79	219,91
1484 40/26 + 1481 26/40	152,68	187,80	186,39	229,26
1484 45/26 + 1481 26/45	161,19	198,26	193,99	238,61
1484 50/26 + 1481 26/50	169,73	208,76	201,59	247,95
1484 55/26 + 1481 26/55	178,25	219,25	209,19	257,30
1405 30/30 + 1400 30/30	135,63	166,83	171,19	210,56
1405 30/35 + 1400 30/35	144,14	177,29	178,79	219,91
1405 30/40 + 1400 30/40	108,02	132,86	130,65	160,70
1405 30/45 + 1400 30/45	127,61	156,96	148,40	182,53
1405 30/50 + 1400 30/50	169,73	208,76	201,59	247,95
1405 30/55 + 1400 30/55	178,25	219,25	201,59	247,95
1405 30/60 + 1400 30/60	186,79	229,75	216,79	266,65
1405 30/65 + 1400 30/65	195,31	240,23	224,39	276,00
1405 30/70 + 1400 30/70	203,84	250,72	231,97	285,33
1405 35/30 + 1400 30/35	144,14	177,29	178,79	219,91
1405 35/35 + 1400 35/35	152,68	187,80	186,39	229,26
1405 35/40 + 1400 35/40	161,19	198,26	193,99	238,61
1405 35/45 + 1400 35/45	169,73	208,76	201,59	247,95
1405 35/50 + 1400 35/50	178,25	219,25	209,19	257,30
1405 35/55 + 1400 35/55	186,79	229,75	216,79	266,65
1405 35/60 + 1400 35/60	195,31	240,23	224,39	276,00
1405 35/65 + 1400 35/65	203,84	250,72	231,97	285,33
1405 35/70 + 1400 35/70	212,37	261,22	239,57	294,68
1405 40/30 + 1400 30/40	108,02	132,86	130,65	160,70
1405 40/35 + 1400 35/40	161,19	198,26	193,99	238,61
1405 40/40 + 1400 40/40	169,73	208,76	201,59	247,95
1405 40/45 + 1400 40/45	178,25	219,25	209,19	257,30
1405 40/50 + 1400 40/50	156,08	191,98	216,79	266,65
1405 40/55 + 1400 40/55	195,31	240,23	214,02	263,24
1405 40/60 + 1400 40/60	169,48	208,46	231,97	285,33
1405 40/65 + 1400 40/65	212,37	261,22	239,57	294,68
1405 40/70 + 1400 40/70	220,88	271,68	247,17	304,02
1405 45/30 + 1400 30/45	127,61	156,96	148,40	182,53
1405 45/35 + 1400 35/45	169,73	208,76	201,59	247,95
1405 45/40 + 1400 40/45	178,25	219,25	209,19	257,30
1405 45/45 + 1400 45/45	186,79	229,75	216,79	266,65

Typ/ Wymiar	Komplety wkładek			
	Klasa B		Klasa C	
	netto	brutto	netto	brutto
1405 45/50 + 1400 45/50	195,31	240,23	224,39	276,00
1405 45/55 + 1400 45/55	169,48	208,46	209,51	257,70
1405 45/60 + 1400 45/60	212,37	261,22	239,57	294,68
1405 45/65 + 1400 45/65	220,88	271,68	247,17	304,02
1405 45/70 + 1400 45/70	245,25	301,66	268,90	330,74
1405 50/30 + 1400 30/50	169,73	208,76	201,59	247,95
1405 50/35 + 1400 35/50	178,25	219,25	209,19	257,30
1405 50/40 + 1400 40/50	156,08	191,98	216,79	266,65
1405 50/45 + 1400 45/50	195,31	240,23	224,39	276,00
1405 50/50 + 1400 50/50	203,84	250,72	231,97	285,33
1405 50/55 + 1400 50/55	212,37	261,22	239,57	294,68
1405 50/60 + 1400 50/60	220,88	271,68	247,17	304,02
1405 50/65 + 1400 50/65	245,25	301,66	268,90	330,74
1405 55/30 + 1400 30/55	178,25	219,25	201,59	247,95
1405 55/35 + 1400 35/55	186,79	229,75	216,79	266,65
1405 55/40 + 1400 40/55	195,31	240,23	214,02	263,24
1405 55/45 + 1400 45/55	169,48	208,46	209,51	257,70
1405 55/50 + 1400 50/55	212,37	261,22	239,57	294,68
1405 55/55 + 1400 55/55	220,88	271,68	247,17	304,02
1405 55/60 + 1400 55/60	220,88	271,68	268,90	330,74
1405 55/65 + 1400 55/65	269,61	331,62	290,61	357,45
1405 60/30 + 1400 30/60	186,79	229,75	216,79	266,65
1405 60/35 + 1400 35/60	195,31	240,23	224,39	276,00
1405 60/40 + 1400 40/60	169,48	208,46	231,97	285,33
1405 60/45 + 1400 45/60	212,37	261,22	239,57	294,68
1405 60/50 + 1400 50/60	220,88	271,68	247,17	304,02
1405 60/55 + 1400 55/60	220,88	271,68	268,90	330,74
1405 60/60 + 1400 60/60	269,61	331,62	290,61	357,45
1405 60/65 + 1400 60/65	293,98	361,59	312,33	384,17
1405 65/30 + 1400 30/65	195,31	240,23	224,39	276,00
1405 65/35 + 1400 35/65	203,84	250,72	231,97	285,33
1405 65/40 + 1400 40/65	212,37	261,22	239,57	294,68
1405 65/45 + 1400 45/65	220,88	271,68	247,17	304,02
1405 65/50 + 1400 50/65	245,25	301,66	268,90	330,74
1405 65/55 + 1400 55/65	269,61	331,62	290,61	357,45
1405 65/60 + 1400 60/65	293,98	361,59	312,33	384,17
1405 70/30 + 1400 30/70	203,84	250,72	231,97	285,33
1405 70/35 + 1400 35/70	212,37	261,22	239,57	294,68
1405 70/40 + 1400 40/70	220,88	271,68	247,17	304,02
1405 70/45 + 1400 45/70	245,25	301,66	268,90	330,74

Master Key



System Master Key to specjalna kombinacja zamknięć i kluczy pozwalająca na otwieranie jednym kluczem wszystkich lub części pomieszczeń w budynku. Każdy z użytkowników swoim kluczem otwiera tylko te pomieszczenia, do których właściciel systemu przyznał mu dostęp. W ramach jednego systemu mogą ze sobą współpracować różne rodzaje zamknięć: wkładki bębnowe, wkładki półówkowe, wkładki elektroniczne, kłódki, zamki wierzchnie i zamki kasetowe.

3VE



- wkładka wykonana zgodnie z normą DIN 18 252/EN 1303
- bębenek: 6 kołków zastawkowych (od rozmiaru 30 mm)
- bębenek: 5 kołków zastawkowych przy wkładkach krótkich o długości 26,5 mm
- 1 kołek obudowy 1 kołek bębna wykonane ze stali hartowanej – jako ochrona przed przewierceniem
- protektor:
 - ochrona profilu klucza przed nieuprawnionym kopiowaniem,
 - ochrona wkładki poprzez dodatkowy element blokujący zamontowany w obudowie
- specjalne zabezpieczenie przed otwarciem metodami wibracyjnymi
- możliwość zastosowania do 12 elementów blokujących na dwóch dodatkowych płaszczyznach. Pierwsze z nich wykonane ze stali hartowanej jako ochrona przed przewierceniem
- 1 kołek specjalny SV w obudowie wkładki
- paracentryczny profil klucza chroniący wkładkę przed otwarciem metodą wibracyjną

TH6



- wkładka wykonana zgodnie z normą DIN 18 252/EN 1303
- bębenek: 6 kołków zastawkowych (od rozmiaru 30 mm)
- bębenek: 5 kołków zastawkowych przy wkładkach krótkich o długości 26,5 mm
- 1 kołek obudowy wykonany ze stali hartowanej jako ochrona przed przewierceniem
- protektor:
 - ochrona profilu klucza przed nieuprawnionym kopiowaniem
 - ochrona wkładki poprzez dodatkowy element blokujący zamontowany w obudowie
- specjalne zabezpieczenie przed otwarciem metodami wibracyjnymi
- możliwość zastosowania do 3 elementów blokujących (boczne kulki zastawkowe)
- 1 kołek specjalny SV w obudowie wkładki
- paracentryczny profil klucza chroniący wkładkę przed otwarciem metodą wibracyjną

STR

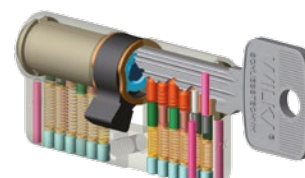

- wkładka wykonana zgodnie z normą DIN 18 252/EN 1303
- bębenek: 6 kołków zastawkowych (od rozmiaru 30 mm)
- bębenek: 5 kołków zastawkowych przy wkładkach krótkich o długości 26,5 mm
- 1 kołek obudowy wykonany ze stali hartowanej – jako ochrona przed przewierceniem
- specjalny kształt bębna umożliwiający precyzyjne wprowadzenie klucza
- paracentryczny profil klucza chroniący wkładkę przed otwarciem metodą wibracyjną

Elementy systemu Master Key



Wkładki dwustronne



Wkładki z galką



Wkładki jednostronne



Kłódki

Projektowanie systemu

Etap 1

- Przeprowadzenie analizy obiektu i określenie wszystkich pomieszczeń, które mają zostać zabezpieczone systemem. W ten sposób wyznaczony zostaje poziom dostępu klucza generalnego. Projektując system należy dążyć do tego aby wyeliminować lub ograniczyć ilość kluczy, które będą funkcjonowały poza systemem. Oznacza to w praktyce, że należy starać się aby system obejmował wszystkie pomieszczenia.
- Określenie rodzaju zamknięć dla poszczególnych pomieszczeń, (np. wkładka dwustronna, kłódka, wkładka jednostronna).
- Również na tym etapie analizuje się i określa kierunki ewentualnej rozbudowy systemu w przyszłości.

Etap 2

- Określenie wszystkich osób, które będą użytkownikami systemu i sprawdzenie czy na pewno wszyscy zostali ujęci.
- Należy również przeanalizować, czy nie jest konieczne dodanie jako użytkowników osób spoza organizacji (np. pracowników serwisowych, ogrodnika itp.).

Etap 3

- Ustalenie hierarchii dostępu poprzez połączenie użytkowników systemu z pomieszczeniami. Jest to bardzo ważny etap, gdyż to od niego zależą późniejsze uprawnienia użytkowników systemu.
- Ostatnią czynnością jest sprawdzenie poprawności dostępu analizując od strony pomieszczeń i użytkowników.

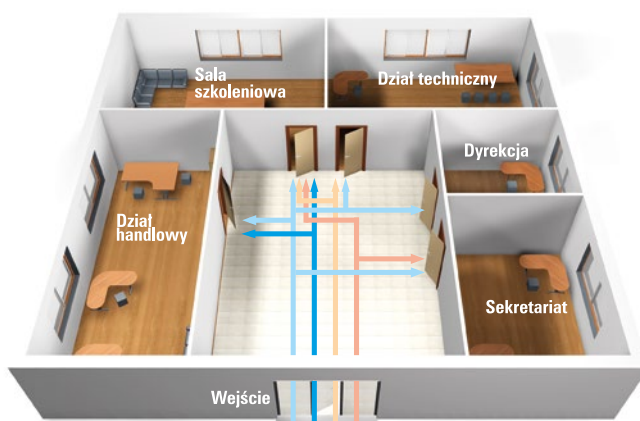

Klucze grupowe		Ilość
GHS	Dyrektor	1
HS1	Kierownik działu handlowego	1
HS2	Kierownik działu technicznego	1
HS3	Asystentka	1

Przykładowe rozwiązanie

W tym przykładowym rozwiązaniu w systemie Master Key funkcjonują 4 klucze. Gdyby ten sam obiekt nie był wyposażony w system, do zapewnienia komunikacji, koniecznych byłoby 15 kluczy.

Elektroniczne szyldy drzwiowe i akcesoria

Szyld został zaprojektowany aby zapewnić wysoki poziom zabezpieczenia a jednocześnie dać możliwość zastosowania do różnego rodzaju drzwi. Sprawdza się wszędzie tam gdzie konieczna jest szybka i prosta zmiana dostępu do pomieszczeń dla gości lub personelu. Jest to rozwiązanie bezprzewodowe, niewymagające okablowania. Pozwala na ochronę pojedynczych drzwi lub połączenie wielu drzwi w sieć, w której możliwe jest nadawanie użytkownikom różnych uprawnień i dostępu. Co bardzo ważne, szyld może współpracować ze standardowym zapadkowym zamkiem wpuszczanym.



Dane techniczne:

- Systemy – easyHotel.
- Współpracuje z zamkami o rozstawach – 72 i 92mm.
- Wymiary – 290 x 40 x 20 mm (DxSxG).
- Wskaźnik LED kolorowy, brzęczyk.
- Powierzchnia – stal nierdzewna.
- Zastosowanie – do drzwi o grubości skrzydła 40-120mm.
- Typ baterii – 3 x AAA, 1,5V:
 - alkaliczne: 30.000 otwarć (2 lata)
 - litowe: 50.000 otwarć (3-4 lata)
- Możliwe specjalne wykonania:
 - mosiądz polerowany
 - mosiądz szczotkowany
- Sposób użytkowania:
 - standard
 - automatycznie otwarte na stałe
 - ręczne otwarcie na stałe
- Temp. użytkowania -20... + 70 °C.
- Stopień ochrony – IP 42 wg EN 60529

Przykładowe zastosowania:

Elektroniczne szyldy drzwiowe mogą być stosowane na przykład w hotelach, biurach, magazynach lub innych pomieszczeniach, w których wymagana jest kontrola dostępu.

D-W074H



Netto	Brutto
17,23	21,19



M3 MAT

D-W075H



Netto	Brutto
17,04	20,96



M91/M6

D-W079H



Netto	Brutto
34,07	41,91



M91/M6

WHZB01



	Netto	Brutto
brąz grafiatto	1,99	2,45
chrom lakierowany	1,91	2,35
nikiel lakierowany	2,03	2,50

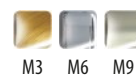

M3 M6 M9

WHZB02



Netto	Brutto
4,28	5,27

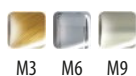

M3 M6 M9

WHZB04



Netto	Brutto
2,82	3,46

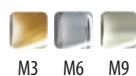

M3 M6 M9

WHZB06



Netto	Brutto
3,69	4,54



M3 M6 M9

TYP-1 / 2 / 4 / 5

Ścienny

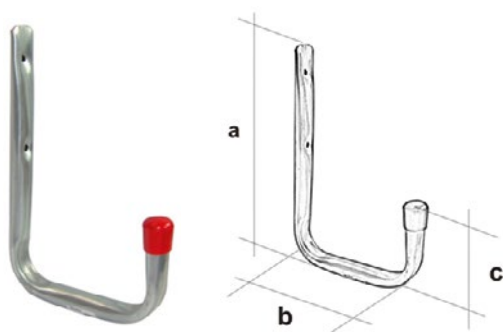

	a	b	b
TYP-1	215	149	90
TYP-2	270	288	92
TYP-4	132	85	50
TYP-5	144	117	52



	Netto	Brutto
D/01 TYP-1 ścienny	5,36	6,59
D/02 TYP-2 ścienny	6,69	8,23
D/04 TYP-4 ścienny	3,28	4,03
D/05 TYP-5 ścienny	3,85	4,74

TYP-3

Sufitowy



	Netto	Brutto
D/03 TYP-3 sufitowy	22,34	27,48

TYP-6

Sufitowy

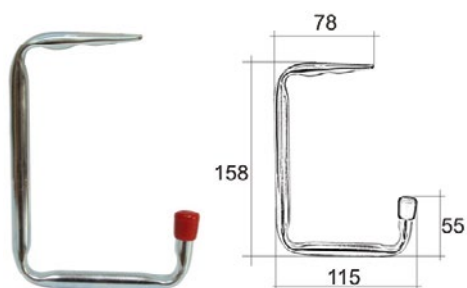

	Netto	Brutto
D/06 TYP-6 sufitowy	5,17	6,35

TYP-13

Ścienno-sufitowy

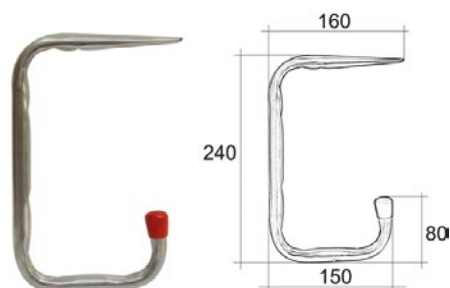

	Netto	Brutto
D/13 TYP-13 ścienno-sufitowy	8,75	10,76

TYP-15

Uniwersalny



	Netto	Brutto
D/15 TYP-15 uniwersalny	23,61	29,04

TYP-19

Na felgi

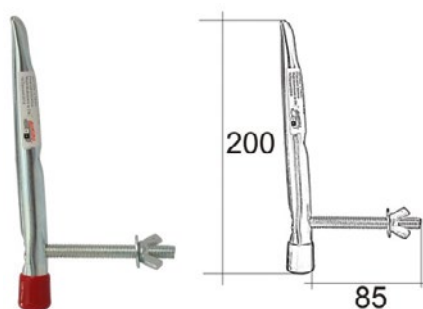

	Netto	Brutto
D/19 TYP-19 na felgi	13,03	16,02

TYP-27 / 28 / 29 / 30

Ścienny

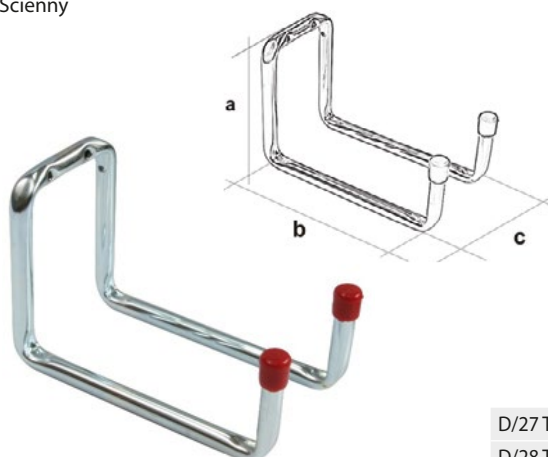

	a	b	b
TYP-27	120	75	90
TYP-28	117	170	90
TYP-29	117	246	90
TYP-30	120	320	90



	Netto	Brutto
D/27 TYP-27 prosty podwójny	9,32	11,46
D/28 TYP-28 prosty podwójny	9,86	12,12
D/29 TYP-29 prosty podwójny	11,28	13,88
D/30 TYP-30 prosty podwójny	13,15	16,18

TYP-33

Na rowery

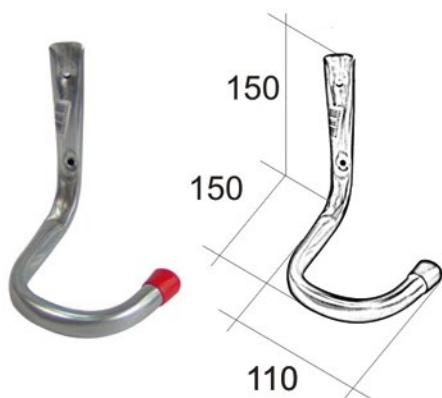

D/33 TYP-33 na rowery

Netto Brutto
8,32 10,23

TYP-34

Podwójny prosty

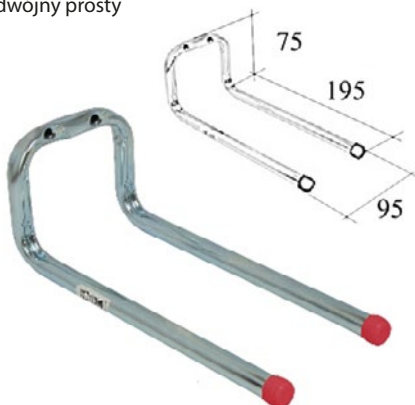

D/34 TYP-34 podwójny prosty

Netto Brutto
6,50 7,99

TYP-36

"S"

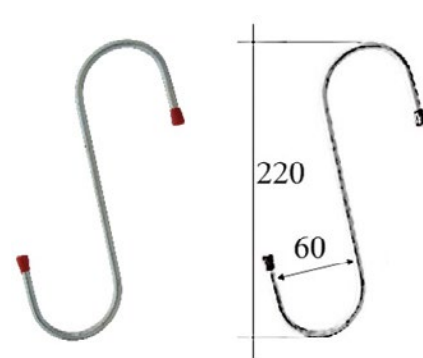

D/36 TYP-36 "S"

Netto Brutto
3,57 4,39

TYP-37

Na deskę windsurfing

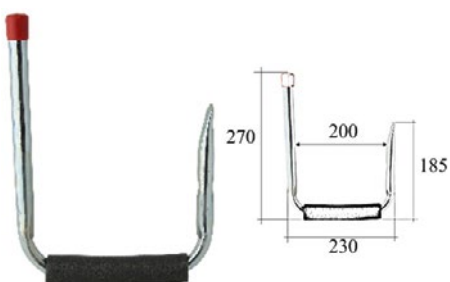

D/37 TYP-37 na deskę windsurfing

Netto Brutto
12,12 14,91

TYP-38

Na felgi



D/38 TYP-38 na felgę

Netto Brutto
20,84 25,63

TYP-39

Na 2 flagi



D/39 TYP-39 na 2 flagi

Netto Brutto
34,07 41,91

TYP-40

Na narty

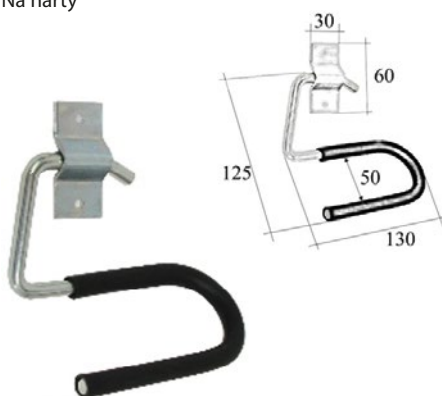

D/40 TYP-40 na narty

Netto Brutto
10,30 12,67

TYP-41

Na skrzynkę



D/41 TYP-41 na skrzynkę

Netto Brutto
5,55 6,82

TYP-42

Na skrzynkę



D/42 TYP-42 na skrzynkę

Netto Brutto
5,86 7,21

Kłódka zatrzaskowa mosiądz



	Netto	Brutto
30-90U141	4,60	5,66
40-90U142	6,76	8,31
50-90U143	11,00	13,53
60-90U144	14,46	17,79

Kłódka żeliwna DMO



	Netto	Brutto
DMO 32	5,69	7,00
DMO 38	6,46	7,95
DMO 50	9,92	12,21
DMO 63	13,69	16,84

Kłódka żeliwna FORMAN



	Netto	Brutto
KZ 38	7,20	8,86
KZ 45	9,22	11,34
KZ 52	10,70	13,16
KZ 63	14,62	17,98

Kłódka B-88 L



NOWOŚĆ

	Netto	Brutto
B-88 L 50mm	9,85	12,11
B-88 L 63mm	12,88	15,84

Kłódka LS



NOWOŚĆ

	Netto	Brutto
LS R50	38,79	47,71
LS R60	46,00	56,58

Kłódka SFX



NOWOŚĆ

	Netto	Brutto
SFX R40	10,06	12,38
SFX R50	12,66	15,57

Y110J/15/111/4



Netto	Brutto
34,89	42,91

Y121



	Netto	Brutto
Y121/40	31,23	38,41
Y121/50	48,61	59,79

Y220



	Netto	Brutto
Y220/51	28,92	35,58
Y220/71	45,45	55,90

YP2/23/128/1



czerwony srebrny żółty



Netto	Brutto
13,46	16,56

Y150



	Netto	Brutto
Y150/22	14,00	17,22
Y150/30	17,44	21,45
Y150/40	23,06	28,36

Active Style



czerwony niebieski srebrny



Netto	Brutto
10,89	13,40

Fashion Dreams



fiolet niebieski róż



Netto	Brutto
10,89	13,40

Street Style



czarny srebrny



Netto	Brutto
10,89	13,40

YLM/200/EG1

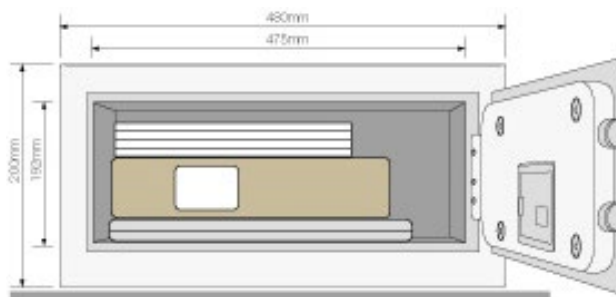

Specyfikacja:

- elektronicznie sterowane 22 mm rygle,
- 6-zapadkowy dwuryglowy zamek odblokowywany ręcznie,
- 2 klucze w zestawie,
- laserowo wycinane drzwi,
- wzmocnione zawiasy i zamontowana sprężyna otwierająca,
- wzmocnione opancerzenie.

Opis:

- cyfrowa klawiatura i podświetlany na niebiesko wyświetlacz,
- kod użytkownika składający się od 3 do 8 cyfr,
- ostrzeżenie o niskim poziomie baterii,
- funkcja włączania/wyłączania wyświetlania kodu,
- oświetlenie wewnętrzne,
- wymiary: 200 x 480 x 350.



Netto Brutto
930,81 1144,89

YSB/250/EB1

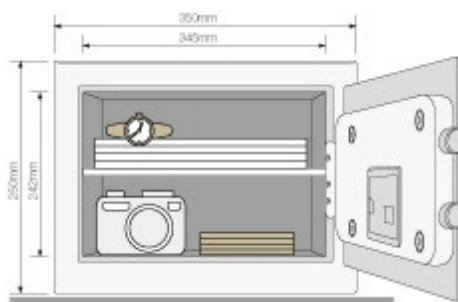

Specyfikacja:

- 22 mm rygle,
- 6-lewarkowy dwuryglowy zamek,
- 2 klucze,
- laserowo wycinane drzwiczki,
- otwory montażowe,
- zbrojone stalowe zaczepy.

Opis:

- cyfrowa klawiatura z wyświetlaczem LCD podświetlanym na niebiesko,
- ostrzeżenie o niskim poziomie baterii,
- funkcja ukrywania wpisywanego kodu,
- wymiary: 250 x 350 x 300.



Netto Brutto
646,17 794,79

YLB/200/EB1

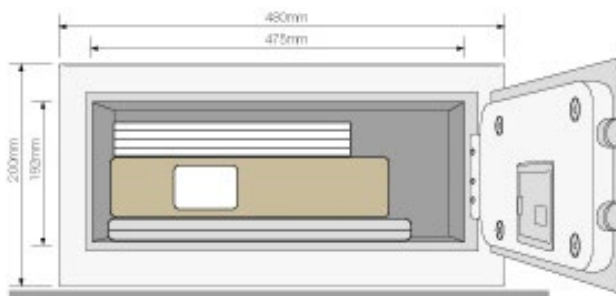

Specyfikacja:

- 22 mm rygle,
- 6-lewarkowy dwuryglowy zamek,
- 2 klucze,
- laserowo wycinane drzwiczki,
- otwory montażowe,
- zbrojone stalowe zaczepy.

Opis:

- cyfrowa klawiatura z wyświetlaczem LCD podświetlanym na niebiesko,
- ostrzeżenie o niskim poziomie baterii,
- funkcja ukrywania wpisywanego kodu,
- wymiary: 200 x 480 x 350.



Netto Brutto
654,37 804,87

YSB/400/EB1

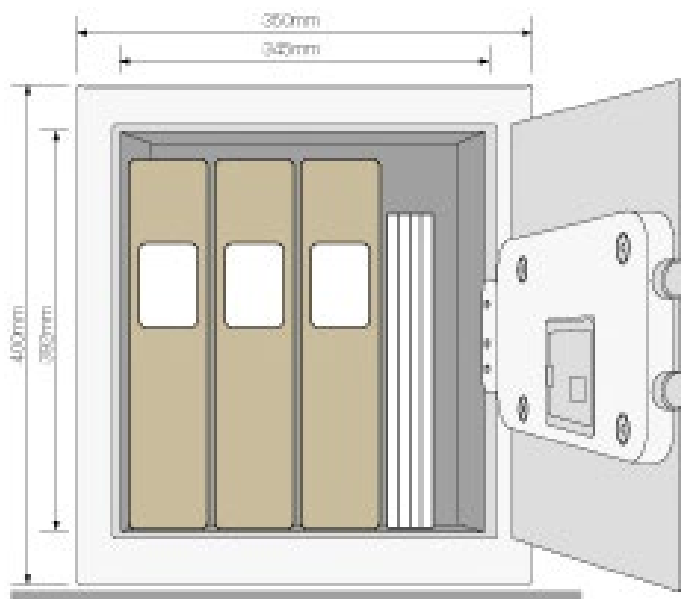

Specyfikacja:

- 22 mm rygle,
- 6-lewarkowy dwuryglowy zamek,
- 2 klucze,
- laserowo wycinane drzwiczki,
- otwory montażowe,
- zbrojone stalowe zaczepy.

Opis:

- cyfrowa klawiatura z wyświetlaczem LCD podświetlanym na niebiesko,
- ostrzeżenie o niskim poziomie baterii,
- funkcja ukrywania wpisywanego kodu,
- wymiary: 400 x 250 x 340.



Netto	Brutto
826,03	1016,02

YSB/200/EB1

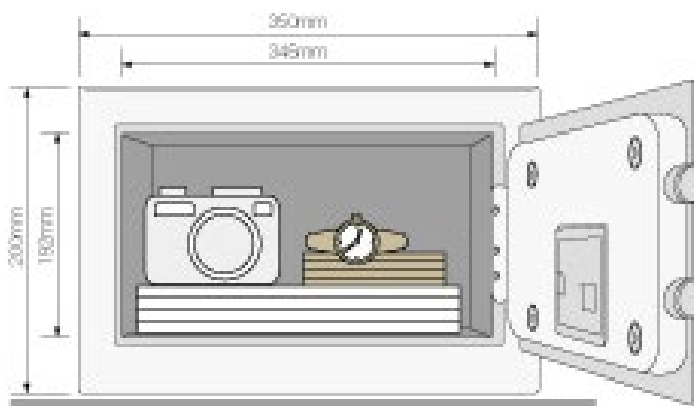

Specyfikacja:

- 22 mm rygle,
- 6-lewarkowy dwuryglowy zamek,
- 2 klucze,
- laserowo wycinane drzwiczki,
- otwory montażowe,
- zbrojone stalowe zaczepy.

Opis:

- cyfrowa klawiatura z wyświetlaczem LCD podświetlanym na niebiesko,
- ostrzeżenie o niskim poziomie baterii,
- funkcja ukrywania wpisywanego kodu,
- wymiary: 200 x 350 x 200.



Netto	Brutto
508,33	625,25

Szczotki drzwiowe 1 mb

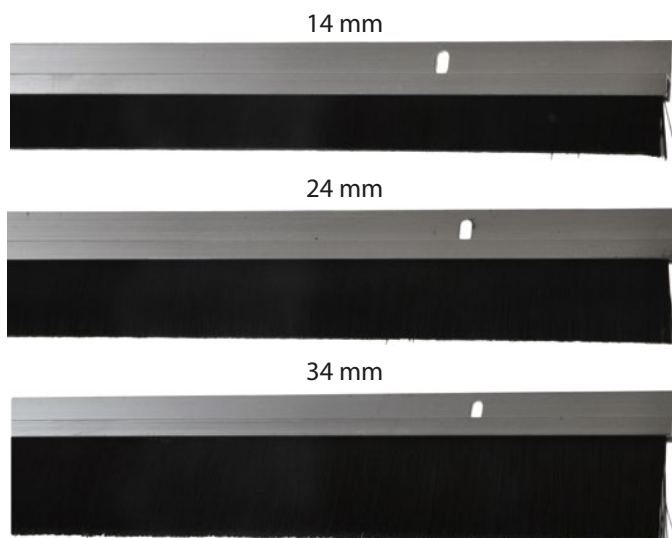

	Netto	Brutto
14 mm	14,46	17,79
24 mm	16,00	19,68
34 mm	16,62	20,44

Listwa progowa

Opadająca aluminiowa

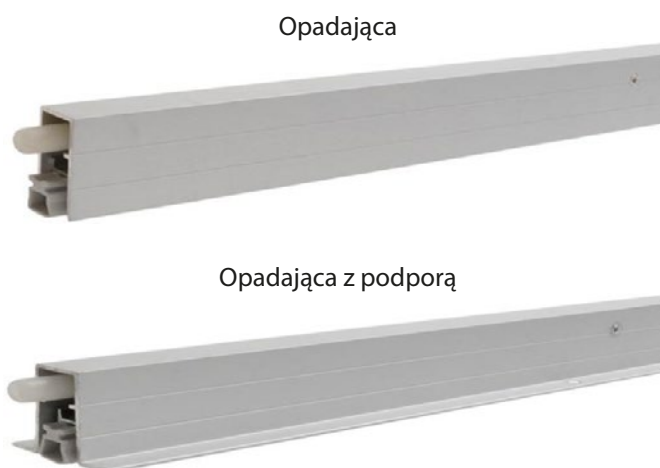

	Netto	Brutto
915x15x44mm	57,26	70,43
1025x15x44mm	58,75	72,26
725x15x44mm z podporą	61,09	75,14
830x15x44mm z podporą	63,93	78,64
915x15x44mm z podporą	66,02	81,20
1025x15x44mm z podporą	67,42	82,93

Listwa uszczelniająca ze szczotką 14 mm

1 mb



	biały		brąz		dąb		sosna	
	netto	brutto	netto	brutto	netto	brutto	netto	brutto
Kątowa aluminiowa	11,99	14,74	-	-	-	-	-	-
Samoprzylepna PCV	11,68	14,37	11,68	14,37	15,48	19,04	15,48	19,04

Listwa uszczelniająca ze szczotką 24 mm

1 mb

NOWOŚĆ

Aluminiowa



Samoprzylepna PCV



domino

	biały		brąz		dąb		sosna		czarny	
	netto	brutto	netto	brutto	netto	brutto	netto	brutto	netto	brutto
Aluminiowa	14,88	18,30	-	-	-	-	-	-	14,88	18,30
Samoprzylepna PCV	12,76	15,70	12,76	15,70	16,53	20,33	16,53	20,33	-	-

Listwa uszczelniająca ze szczotką 34 mm

Kątowa aluminiowa 1 mb

NOWOŚĆ



domino

Netto	Brutto
14,57	17,92

Listwa uszczelniająca ze szczotką 45 mm

Aluminiowa 1 mb

NOWOŚĆ

 biały
 czarny

domino

Netto	Brutto
19,98	24,58

Listwa uszczelniająca ze szczotką 60 mm

Przykręcana aluminiowa 1 mb

NOWOŚĆ



domino

Netto	Brutto
37,80	46,50

Skrzynka HPB1402

Na listy



Netto	Brutto
123,83	152,32

NOWOŚĆ

Skrzynka HPB2210

Na listy



Netto	Brutto
103,69	127,54

NOWOŚĆ

Skrzynka HPB2211

Na listy



Netto	Brutto
114,62	140,98

NOWOŚĆ

Skrzynka HPB918

Na listy



Netto	Brutto
123,83	152,32

NOWOŚĆ

Skrzynka HPB918 N

Na listy



Netto	Brutto
114,62	140,98

NOWOŚĆ

Skrzynki na klucze

NOWOŚĆ



	Netto	Brutto
20 kluczy	38,31	47,12
48 kluczy	46,00	56,58
96 kluczy	76,77	94,43

Szafa S 01



Szafa akcesoria



Szafa S 02



Szafa S 03



Regał S 05



Ekspozytor S 06



Ekspozytor S 07



Plansza S 03



- wymiary szaf dostosowane do potrzeb Klienta
- ilość przegród do uzgodnienia
- standardowa szafa o wymiarach: 1970x1320x500
- plansze ekspozycyjne S03 robione pod indywidualne zamówienie

KLAMKI WEWNĘTRZNE

Klamki na dzielonym szyldzie kwadratowym

Alma-QR	4
Coral-QR	4
Dots-QR	4
Fenix-QR	4
Fero-QR	4
Figo-QR	4
Fokus-QR	4
Fremo-QR	4
Galaxy-QR	4
Gustaw-QR	5
Iggy-QR	5
Insignia-QR	5
Jane-QR	5
Jaro-QR	5
Jaro-QR ECO	5
Kyrk-QR	5
Logo-QR	5
Milano-QR	5
Modena-QR	6
Net-QR	6
Omega-QR	6
Palermo-QR	6
Presto-QR	6
Qubik-QR	6
Romana-QR	6
Sky-QR	6
Time-QR	6
Tom-II-QR	6
Tre-QR	6

Klamki na dzielonym szyldzie okrągłym

Afrodyta-R	8
Alma-R	8
Alma-R economy	8
Atena-R	8
Ballen-R	8
Bilbao-R	8
Biskopt-R	8
Casablanca-R	8
Econom-R	9
Elisabeth-R	9
Fly-R economy	9
Focus-R	9
Galaxy-R	9
Gussy-R	9
Ibis-R	9
Insignia-R	9
Jane-R	10
Jane-R AG1	10
Jaro-R	10
Jaro-R ECO	10
Jola-R	10
Kyrk-R	10
Lavia-R	10
Loft-R	10
Malta-R	11
Marion-R	11
Modena-R	11
Monaco-R	11
Nova-R	11
Omega-R	11

Oslo-R	11
Otto-R	11
Palermo-R	11
Petra-R	12
Presto-R	12
Pro-R	12
Romana-R	12
Sharon-R	12
Tiger-R	12
Time-R	12
Wing-R	12

Klamki na długim szyldzie

Afrodyta	14
Alma	14
Alma economy	14
Anna	14
Ares	14
Atena	14
Ballen	14
Bilbao	14
Biskopt	15
Casablanca	15
Econom	15
Elizabeth	15
Fero	15
Fly economy	15
Fokus	15
Galaxy	15
Gussy	16
Hades P18	16
Ibis	16
Insignia	16
Istambuł	16
Jane	16
Jaro	16
Jaro economy	16
Jola	16
Kyrk	17
Loft	17
Malta	17
Modena	17
Monaco	17
Nova	17
Oslo	17
Otto	17
Palermo	17
Petra	18
Presto	18
Pro	18
Romana	18
Tiger	18
Time	18
Tre	18
Wing	18

Klamki ze stali nierdzewnej

Agnessa-QR	20
Amir 2230-R	20
Aveiro-QR	20
Finger 2252-QR	20
Finger 2252-R	20
Golf 2233-R	20
Grisza-QR	20
Image 2002-QR	20
Image 2002-R	20
Image 2072	21

Jane-QR	21
Lido 2001-R	21
Lido 2071	21
Liu-R	21
Luka-QR	21
Padwa-R	21
Prado-R	21
Prima 2232-R	21
Rondo 2000-R	21
Rondo 2003	21
Rondo 2003/2006	22
Rondo 2070	22
Siena-R	22
Sigma-QR	22
Sigma-R	22
Sigma-R Owal	22
Uno	22
Uno Gałka	22
Uno 170	22
Uno 170 Gałka	22
Uno-R	22
Uno-R Owal	22

Szyldy

900	24
AlmaQ	24
950	24
EF KWADRAT INX	24
Jane AG1	24
EF-lui	24
EF-100	25
EF-200	25
Pro	25
Econom	25
EF OWAL	25
QUADRO	25
QUADRO M6/M9	26
Tiger	26
SP Biskopt	26
SN04	26
0006 Plus	26
10710	26
Owalny Plus	26

Gałki

1924-Q	28
2006	28
2055	28
2065	28
2075	28
Klamka Alma+G	28
6711 Prosta	28
6871 Kula	28

KLAMKI ZEWNĘTRZNE

AXA K+K	30
Fokus K+K	30
Galaxy K+K	30
Haga K+K	30
Jane K+K	30
Lana K+K	30
Lana K+P	30
Manitoba K+K	30
Marseille K+K	30
Nestor K+K	31
New York K+K	31

Niagara K+K	31
Niagara K+P	31
Note K+K	31
Note K+K z zabezpieczeniem	31
Note K+P	31
Note K+P z zabezpieczeniem	31
Omega-zew. K+K	31
Ottawa K+K	32
Prestige K+G	32
Prestige K+G z zabezpieczeniem	32
Prestige K+K	32
Prestige K+K z zabezpieczeniem	32
Quebec K+K	32
Retro K+K	32
Rondo K+G	32
Rondo K+G z zabezpieczeniem	32
Rondo K+K	33
Rondo K+K z zabezpieczeniem	33
Royal K+K	33
Royal K+K z zabezpieczeniem	33
Slim K+K	33
Space K+K	33
Space K+K z zabezpieczeniem	33
Stratos K+K	33
Tokyo K+K	33
Dostępne rozstawy klamek do drzwi zewnętrznych	34

KLAMKI OKIENNE

Agueda-QO	36
Amir-O	36
Aveiro-QO	36
Demeter-O	36
Faro-QO	36
Finger-QO	36
Golf-O	36
Image-QO	36
Kora-O	36
Lamia-O	36
Lido-O	36
Lizbona-QO	36
Mateo-O	36
Neris-QO	36
Panteon-QO	36
Pluton-O	36
Pluton-O F1, F4, F9 + zamek	37
Pluton-O + zamek	37
Pluton-O F1, F4, F9	37
Pombal-QO	37
Porto-QO	37
Prima-O	37
Roma-O	37
Rondo-O	37
Scorpius-O	37
Secustic-O T35 do drewna	37
Secustic-O T32 do PCV	37
Secustic-O z kluczykiem	37
Secustic-O z przyciskiem	37
Victoria-QO	37
Vigo-QO	37
Wenus-O	37
Westa-O	37
Zita-O	37

AKCESORIA

Zamki do drzwi szklanych

Zamek do drzwi szklanych V-100	40
Zamek do drzwi szklanych V-5000	40
Zamek do drzwi szklanych V-6000	40

Pochwyty do drzwi przesuwanych, Pochwyty

Pochwyty 092 mosiężny	41
Pochwyty 095 mosiężny	41
Pochwyty magnetyczny ZnAl 2649	41
Pochwyty magnetyczny ZnAl 2650	41
Pochwyty 090 ZnAl	42
Pochwyty 3524 mosiężny	42
Pochwyty stal nierdzewna	42
Pochwyty tworzywo	42
Pochwyty balkonowy	42
Pochwyty aluminiowy	42
Pochwyty jednostronny	43
Pochwyty dwustronny prostokątny	43
Pochwyty dwustronny prosty Ø 32	43
Pochwyty dwustronny odgięty Ø 32	43

Tuleje wentylacyjne

Tuleje wentylacyjne okrągłe Ø 40 stalowe, gr. 38-42 mm	44
Tuleje wentylacyjne kwadratowe Ø 40 stalowe, gr. 38-42 mm	44
Tuleje wentylacyjne Ø 40, grubość: 36-46 mm	44
Tuleje wentylacyjne kwadratowe Ø 40, gr. 36-46 mm	44
Tuleje wentylacyjne Ø 40, grubość: 30-40 mm	44
Tuleje wentylacyjne kwadratowe Ø 40, gr. 30-40 mm	44
Tuleje wentylacyjne Ø 22 mosiężne (szt.)	45
Tuleje wentylacyjne Ø 30 mosiężne	45
Tuleje wentylacyjne Ø 35 mosiężne (szt.)	45
Tuleje wentylacyjne Ø 40 mosiężne, grubość: 35-38 mm	45
Tuleje wentylacyjne Ø 40 mosiężne, grubość: 38-42 mm	45
Tuleje tworzywo	45

Cyfry i oznaczenia

Kratki wentylacyjne	46
Oznaczenia WC samoprzylepne PCV	46
Oznaczenia WC samoprzylepne	46
Oznaczenia WC	46
Cyfry 5 cm: od 0 do 9 samoprzylepne	46

Cyfry 19 cm: od 0 do 9 samoprzylepne PCV	46
Cyfry 10 cm: od 0 do 9 samoprzylepne	46
Cyfry 20 cm: od 0 do 9 samoprzylepne	46
Cyfry samoprzylepne PCV	46
Litery samoprzylepne PCV	46
Myślniki samoprzylepne PCV	46

Zamki hakowe

Zamek 3910	47
Zamek 3911	47
Zamek HOMER	47

Zamki, Blachy zaczepowe

Jednostronne	48
Zamek BOX	48
Zamki Boda	48
Blachy zaczepowe BODA	49
Elektrozaczepy	49
Rygiel AFX	49
Zasuwka AFX	49
Zamki JANIA	50
Zamki JANIA bramowe	50
Zamek oszczędnościowy	50
Zamek GERDA ZG	51
Zamek GERDA ZN	51
Zamek GERDA ZX	51

Zamki magnetyczne

Zamek magnetyczny HOMER	52
Zamki B FOUR	52
Zamki B TWO	52

Odboje

Odbojniki kuliste	53
Odboje mosiężne podłoga niski	53
Odboje mosiężne podłoga	53
Odboje mosiężne ściana	53
Odboje gumowe	53
Odboje magnetyczne	54
Odboje tworzywo	54
Odboje INX	54
Odboje	54

Stoper | Zawiasy

Stoper	55
Zawias KUBICA	55
Zawias 1800	55
Zawias Invisible	55
Zawias 1722 INOX	55

Zawiasy wkręcane

Zawias mosiężny	56
Zawias regulowany OTLAV	56
Zawias regulowany POLSOFT	56
Zawias regulowany LA FLORIDA	56
Zawias regulowany	56
Zawias Invisible 830	57
Zawias Invisible	57
Zawiasy CAB-R	57

Osłonki

Osłonki zawiasu 13,5 x 80, tworzywo	57
Osłonki zawiasu, aluminium	57

Wizjery

Wizjery	58
---------	----

Akcesoria

Zestaw montażowy klamki	58
Reduktory średnicy pręta WC	58

Pręt kwadratowy	58
Śruby przelotowe	58
Wkręty do klamek	58
Śrubka imbusowa	58

Samozamykacze

TS 1000 z ramieniem	59
TS 1500 z ramieniem	59
TS 2000 V z ramieniem	59
TS 1500 z ramieniem z blokadą	59
TS 2000 V-BC z ramieniem	60
TS 2000 z ramieniem z blokadą	60
TS 3000 V z szyną	60
Szyny ślizgowe	60

Kołatki

Kołatka CH Barocco	61
Kołatka CH Tondo	61
Kołatka Victorian	61

Wkładki

Wkładki DMO dwustronna	62
Wkładki DMO z gałką	62
Wkładki DMO zestaw wkładek	62
Wkładki DMO ECO dwustronna	63
Wkładki DMO ECO z gałką	63
Wkładka GERDA WKE1	63
ECOLINE K5	63
Wkładki bębnekowe	64
Zestaw wkładek jednakowo kodowanych	65
Master Key	66

Wieszaki

D-W074H	68
D-W075H	68
D-W079H	68
WHZB01	68
WHZB02	68
WHZB04	68
WHZB06	68

Haki garażowe

TYP-1 / 2 / 4 / 5	69
TYP-3	69
TYP-6	69
TYP-13	69
TYP-15	69
TYP-19	69
TYP-27 / 28 / 29 / 30	69
TYP-33	70
TYP-34	70
TYP-36	70
TYP-37	70
TYP-38	70
TYP-39	70
TYP-40	70
TYP-41	70
TYP-42	70

Kłódki

Kłódka zatraskowa mosiądz	71
Kłódka żeliwna DMO	71
Kłódka żeliwna FORMAN	71
Kłódka B-88 L	71
Kłódka LS	71
Kłódka SFX	71
Y110J/15/111/4	72
Y121	72
Y220	72
YP2/23/128/1	72

Y150	72
Active Style	72
Fashion Dreams	72
Street Style	72

Sejfy

YLM/200/EG1	73
YSB/250/EB1	73
YLB/200/EB1	73
YSB/400/EB1	74
YSB/200/EB1	74

Listwy

Szczotki drzwiowe 1 mb	75
Listwa progowa	75
Listwa uszczelniająca ze szczotką 14 mm	75
Listwa uszczelniająca ze szczotką 24 mm	76
Listwa uszczelniająca ze szczotką 34 mm	76
Listwa uszczelniająca ze szczotką 45 mm	76
Listwa uszczelniająca ze szczotką 60 mm	76

Skrzynki

Skrzynka HPB1402	77
Skrzynka HPB2210	77
Skrzynka HPB2211	77
Skrzynka HPB918	77
Skrzynka HPB918 N	77
Skrzynki na klucze	77

Formy ekspozycji

Szafa S 01	78
Szafa akcesoria	78
Szafa S 02	78
Ekspozytor S 06	78
Ekspozytor S 07	78
Szafa S 03	78
Regał S 05	78
Plansza S 03	78



Region **A**
601 770 498
d.nowacki@domino.pl
74 667 04 12
r.jurczenko@domino.pl

Region **B**
609 830 644
r.zajac@domino.pl
74 832 32 52
i.jechna@domino.pl

Region **C**
605 256 868
j.lysiak@domino.pl
74 667 04 16
m.lewandowska@domino.pl

Region **D**
603 508 923
s.wawrzylo@domino.pl
74 832 48 07
a.wieczorek@domino.pl

Region **E**
601 141 556
s.sas@domino.pl
74 832 10 11
k.kaczor@domino.pl

domino sp.j.

ul. Rzeźnicza 4
58-200 Dzierżoniów
www.domino.pl
hurt@domino.pl
fax 74 660 79 79