



DH-17 FUTURE

ZnAl

New!



DH-17-22-AB-KW



PLT-23-N-AB-KW



PLT-23-Y-AB-KW



PLT-23WC-AB-KW

New!



PLT-25-N-AB-KW



PLT-25-Y-AB-KW



PLT-25WC-AB-KW



G0006



G0007



G00AB



G011M

G0006 - nikiel satynowy / satin nickel
Nickel satiniert (matt) / сатиновый никель
níquel satinado / nickel satiné

G00AB - mosiądz antyczny / antique brass
Antikmessing / античная латунь
latón antiguo / laiton antique

G0007 - nikiel szczotkowany / brushed nickel
Nickel gebürstet (Edelstahloptik) / крацованный никель
níquel cepillado / nickel brossé

G011M - grafit / graphite / Grafit / графит / grafito / graphitev

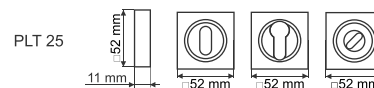
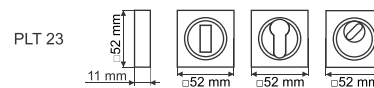
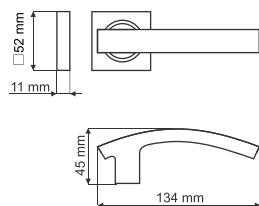





Klamki
wewnętrzne

Internal door
handles

Innenraum
Türdrücker

Ручки для
внутренних дверей

Manillas
internas

Poignées
intérieures

DH-A GAJA

ZnAl



DH-A-11N-72-AB



DH-A-11Y-72-AB



DH-A-11WC-AB-P



PLT-23-N-AB



PLT-25-N-AB

New!



DH-A-22-AB



PLT-23-Y-AB



PLT-25-Y-AB



PLT-23WC-AB



PLT-25WC-AB



G0003



G0004



G0006



G0007



G0008



G00AB

G0003 - mosiądz / brass
Messing / латунь
latón / laiton

G0004 - chrom / chrome
Chrom glänzend / хром
cromo / chrome

G0006 - nikiel satynowy / satin nickel
Nickel satiniert (matt) / сатиновый никель
níquel satinado / nickel satiné

G0007 - nikiel szczotkowany / brushed nickel
Nickel gebürstet (Edelstahl-optik) / крацованный никель
níquel cepillado / nickel brossé

G0008 - chrom satynowy / satin chrome
Chrom satiniert (matt) / сатиновый хром
cromo satinado / chrome satiné

G00AB - mosiądz antyczny / antique brass
Antikmessing / античная латунь
latón antiguo / laiton antique

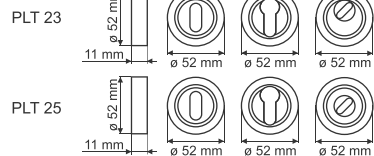
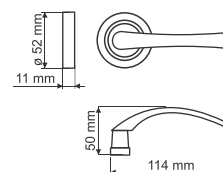
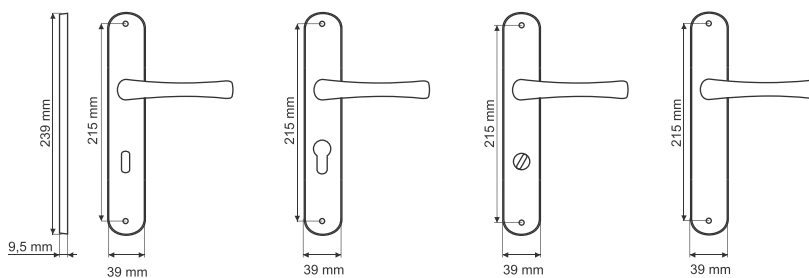

Standardowy rozstaw otworów (klucz-wkładka): 72mm. Rozstaw 90mm na indywidualne zamówienie. Klamka z szyldem w wersji (P) prawa i (L) lewa.
Standard c.c. (key - insert): 72 mm, c.c. (key - insert): 90 mm on individual orders. Door handle on a backplate in (P) right and (L) left versions.
Lochabstand Schlüssel-Zylinderschloss: 72mm. Abstand 90mm auf individuelle Anfrage. Türdrücker mit dem Schild WC ist in 2 Varianten verfügbar: (P)- rechts und (L)-links.
Стандартная длина между отверстиями (ключ - вкладка): 72 мм. Длина 90 мм - только на индивидуальный заказ.
La distancia estándar entre agujeros (llave-cilindro monoblock): 72mm. La distancia de 90 mm bajo pedido de cliente. Manilla con placa disponible en versiones: derecha (P) e izquierda (L).
Espacement d'orifices standard (def-insert) : 72 mm. Espacement 90 mm sur commande. Poignée avec plaque en version (P) droite et (L) gauche.

DH-B LEDA

ZnAl



G0003



G0004



G0006



G0007



G0008



G00AB

G0003 - mosiądz / brass
Messing / латунь
latón / laiton

G0004 - chrom / chrome
Chrom glänzend / хром
cromo / chrome

G0006 - nikiel satynowy / satin nickel
Nickel satiniert (matt) / сатиновый никель
níquel satinado / nickel satiné

G0007 - nikiel szczotkowany / brushed nickel
Nickel gebürstet (Edelstahloptik) / крацованный никель
níquel cepillado / nickel brossé

G0008 - chrom satynowy / satin chrome
Chrom satiniert (matt) / сатиновый хром
cromo satinado / chrome satiné

G00AB - mosiądz antyczny / antique brass
Antikmessing / античная латунь
latón antiguo / laiton antique

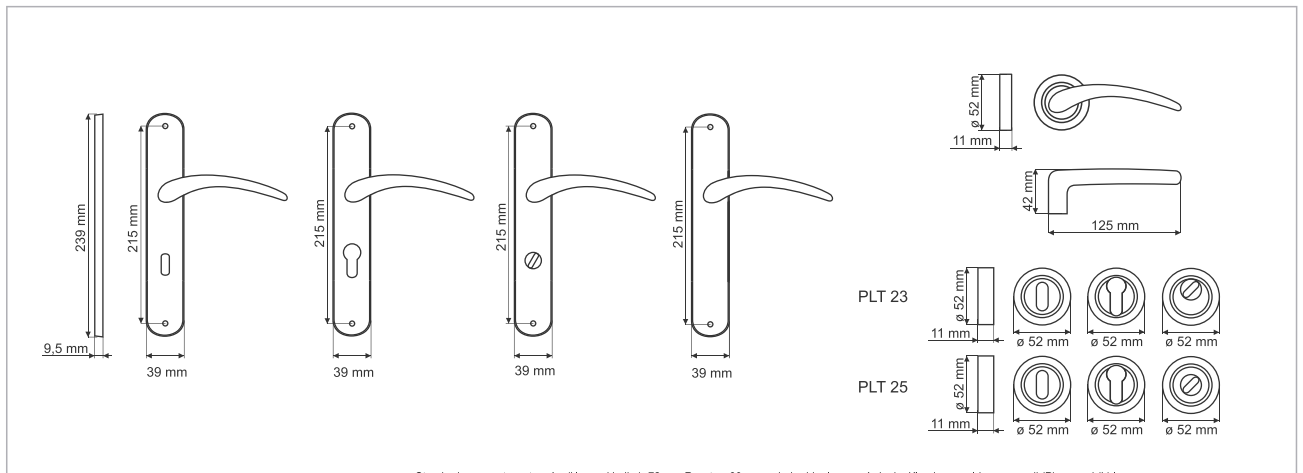

Standardowy rozstaw otworów (klucz-wkładka): 72mm, Rozstaw 90mm na indywidualne zamówienie. Klamka z szyldem w wersji (P) prawa i (L) lewa.
Standard c.c. (key-insert): 72 mm, c.c. (key-insert): 90 mm on individual orders. Door handle on a backplate in (P) right and (L) left versions.
Lochabstand Schlüssel-Zylinderschloss : 72mm, Abstand 90mm auf individuelle Anfrage. Türdrücker mit dem Schild WC ist in 2 Varianten verfügbar: (P) rechts und (L) links.
Стандартная длина между отверстиями (ключ – вкладка): 72 мм. Длина 90 мм – только на индивидуальный заказ.
La distancia estándar entre agujeros (lave-cilindro monoblock): 72mm, La distancia de 90 mm bajo pedido de cliente. Manilla con placa disponible en versiones: derecha (P) e izquierda (L).
Espacement d'orifices standard (def-insert) : 72 mm, Espacement 90 mm sur commande, Poignée avec plaque en version (P) droite et (L) gauche.



DH-C TITAN

ZnAl



DH-C-22-06-KW



PLT-23-N-06-KW



PLT-23-Y-06-KW



PLT-23WC-06-KW

New!



PLT-25-N-06-KW



PLT-25-Y-06-KW



PLT-25WC-06-KW



G0006



G0007



G00AB

G0006 - nikiel satynowy / satin nickel
Nickel satiniert (matt) / сатиновый никель
níquel satinado / nickel satiné

G0007 - nikiel szczotkowany / brushed nickel
Nickel gebürstet (Edelstahloptik) / крацованный никель
níquel cepillado / nickel brossé

G00AB - mosiądz antyczny / antique brass
Antikmessing / античная латунь
latón antiguo / laiton antique

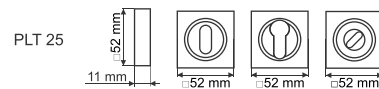
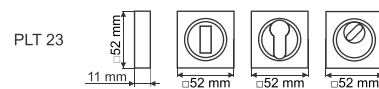
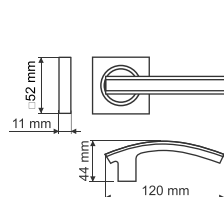

DH-C TITAN

ZnAl



G0006



G0007



G00AB

G0006 - nikiel satynowy / satin nickel
Nickel satiniert (matt) / сатиновый никель
niquel satinado / nickel satiné

G0007 - nikiel szczotkowany / brushed nickel
Nickel gebürstet (Edelstahloptik) / крацованный никель
niquel cepillado / nickel brossé

G00AB - mosiądz antyczny / antique brass
Antikmessing / античная латунь
latón antiguo / laiton antique

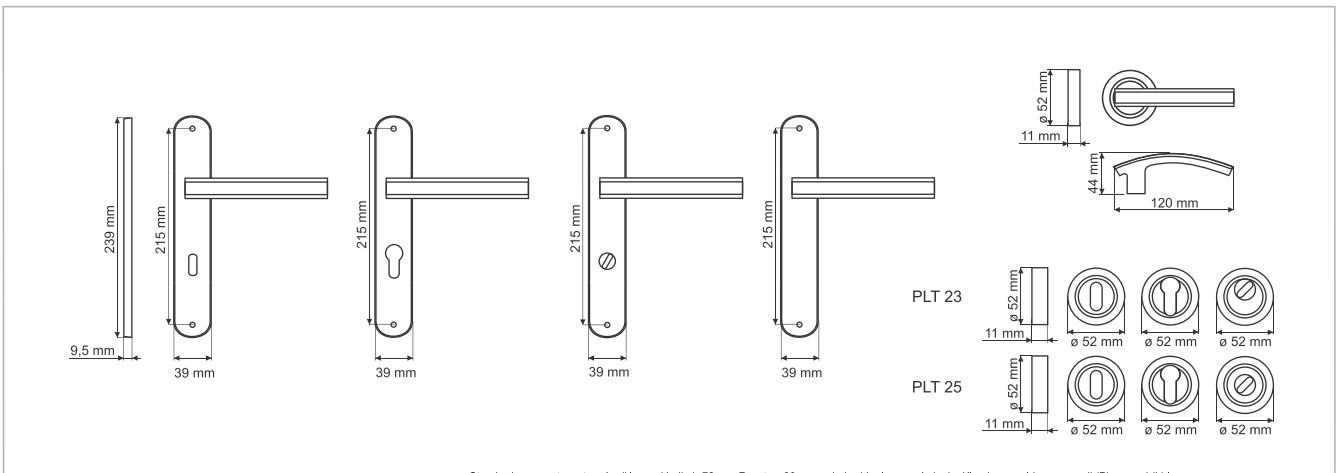

Standardowy rozstaw otworów (klucz-wkładka): 72mm, Rozstaw 90mm na indywidualne zamówienie. Klamka z szyldem w wersji (P) prawa i (L) lewa.
Standard c.c. (key-insert): 72 mm, c.c. (key-insert): 90 mm on individual orders. Door handle on a backplate in (P) right and (L) left versions.
Lochabstand Schlüssel-Zylinderschloss : 72mm, Abstand 90mm auf individuelle Anfrage. Türdrücker mit dem Schild WC ist in 2 Varianten verfügbar: (P) rechts und (L) links.
Стандартная длина между отверстиями (ключ – вкладка): 72 мм. Длина 90 мм – только на индивидуальный заказ.
La distancia estándar entre agujeros (lave-cilindro monoblock): 72mm, La distancia de 90 mm bajo pedido de cliente. Manilla con placa disponible en versiones: derecha (P) e izquierda (L).
Espacement d'orifices standard (clef-insert) : 72 mm, Espacement 90 mm sur commande, Poignée avec plaque en version (P) droite et (L) gauche.



Klamki
wewnętrzne

Internal door
handles

Innenraum
Türdrücker

Ручки для
внутренних дверей

Manillas
internas

Poignées
intérieures

DH-E MARITIMO

ZnAl



DH-E-111N-72-AB



DH-E-111Y-72-AB



DH-E-111WC-AB



PLT-23-N-AB



PLT-25-N-AB



DH-E-22-07



PLT-23-Y-AB



PLT-25-Y-AB



PLT-23WC-AB



PLT-25WC-AB

New!



G0005



G0006



G0007



G00AB



GA011

G0005 - patyna na miedzi / patinated brass
Messing patiniert / патина на латуни
latón patinado / patine sur laiton

G00AB - miedź antyczna / antique brass
Antikmessing / античная латунь
latón antiguo / laiton antique

G0006 - nikiel satynowy / satin nickel
Nickel satiniert (matt) / сатиновый никель
níquel satinado / nickel satiné

GA011 - nikiel patynowany / patinated nickel
Nickel patiniert / патинированный никель
níquel patinado / nickel patiné

G0007 - nikiel szczotkowany / brushed nickel
Nickel gebürstet (Edelstahloptik) / крацованный никель
níquel cepillado / nickel brossé

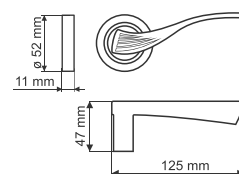
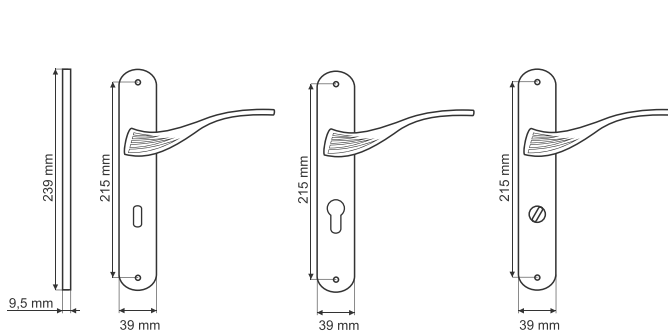

PLT 23

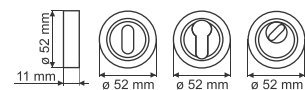

PLT 25

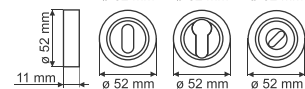

Standardowy rozstaw otworów (klucz-wkładka): 72mm. Rozstaw 90mm na indywidualne zamówienie. Klamka z szyldem w wersji (P) prawa i (L) lewa.
Standard c.c. (key - insert): 72 mm, c.c. (key - insert): 90 mm on individual orders. Door handle on a backplate in (P) right and (L) left versions.
Lochabstand Schlüssel-Zylinderschloss : 72mm. Abstand 90mm auf individuelle Anfrage. Türdrücker mit dem Schild WC ist in 2 Varianten verfügbar: (P)- rechts und (L) -links.
Стандартная длина между отверстиями (ключ - вкладка): 72 мм. Длина 90 мм - только на индивидуальный заказ.
La distancia estándar entre agujeros (llave-cilindro monoblock): 72mm. La distancia de 90 mm bajo pedido de cliente. Manilla con placa disponible en versiones: derecha (P) e izquierda (L).
Espacement d'orifices standard (clef-insert) : 72 mm. Espacement 90 mm sur commande. Poignée avec plaque en version (P) droite et (L) gauche.





DH-I INFERO

ZnAl



DH-I-112N-72-AB



DH-I-112Y-72-AB



DH-I-112WC-AB-P



G0006



G0007



G00AB

G0006 - nikiel satynowy / satin nickel
Nickel satiniert (matt) / сатиновый никель
níquel satinado / nickel satiné

G0007 - nikiel szczotkowany / brushed nickel
Nickel gebürstet (Edelstahloptik) / крацованный никель
níquel cepillado / nickel brossé

G00AB - mosiądz antyczny / antique brass
Antikmessing / античная латунь
latón antiguo / laitón antique

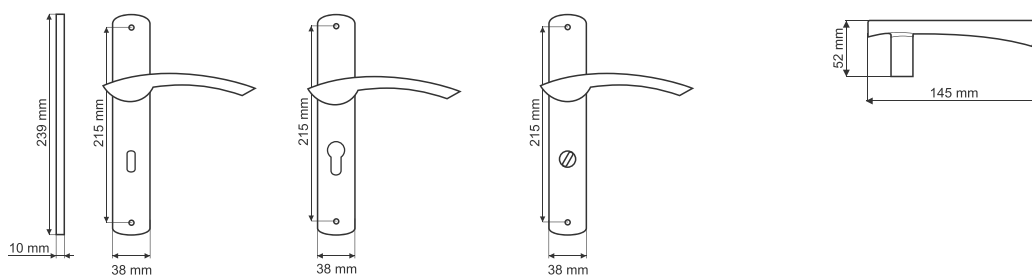

Standardowy rozstaw otworów (klucz-wkładka): 72mm. Rozstaw 90mm na indywidualne zamówienie. Klamka z szyldem w wersji (P) prawa i (L) lewa.
Standard c.c. (key - insert): 72 mm, c.c. (key - insert): 90 mm on individual orders. Door handle on a backplate in (P) right and (L) left versions.
Lochabstand Schlüssel-Zylinderschloss : 72mm. Abstand 90mm auf individuelle Anfrage. Türdrücker mit dem Schild WC ist in 2 Varianten verfügbar: (P)- rechts und (L)-links.
Стандартная длина между отверстиями (ключ - вкладка): 72 мм. Длина 90 мм - только на индивидуальный заказ.
La distancia estándar entre agujeros (llave-cilindro monoblock): 72mm. La distancia de 90 mm bajo pedido de cliente. Manilla con placa disponible en versiones: derecha (P) e izquierda (L).
Espacement d'orifices standard (clef-insert) : 72 mm. Espacement 90 mm sur commande. Poignée avec plaque en version (P) droite et (L) gauche.

DH-O ODA

ZnAl



G0003 - mosiądz / brass
Messing / латунь
latón / laiton

G0004 - chrom / chrome
Chrom glänzend / хром
cromo / chrome

G0006 - nikiel satynowy / satin nickel
Nickel satiniert (matt) / сатиновый никель
níquel satinado / nickel satiné

G0007 - nikiel szczotkowany / brushed nickel
Nickel gebürstet (EdelstahlOptik) / крацованный никель
níquel cepillado / nickel brossé

G0008 - chrom satynowy / satin chrome
Chrom satiniert (matt) / сатиновый хром
cromo satinado / chrome satiné

G00AB - mosiądz antyczny / antique brass
Antikmessing / античная латунь
latón antiguo / laiton antique

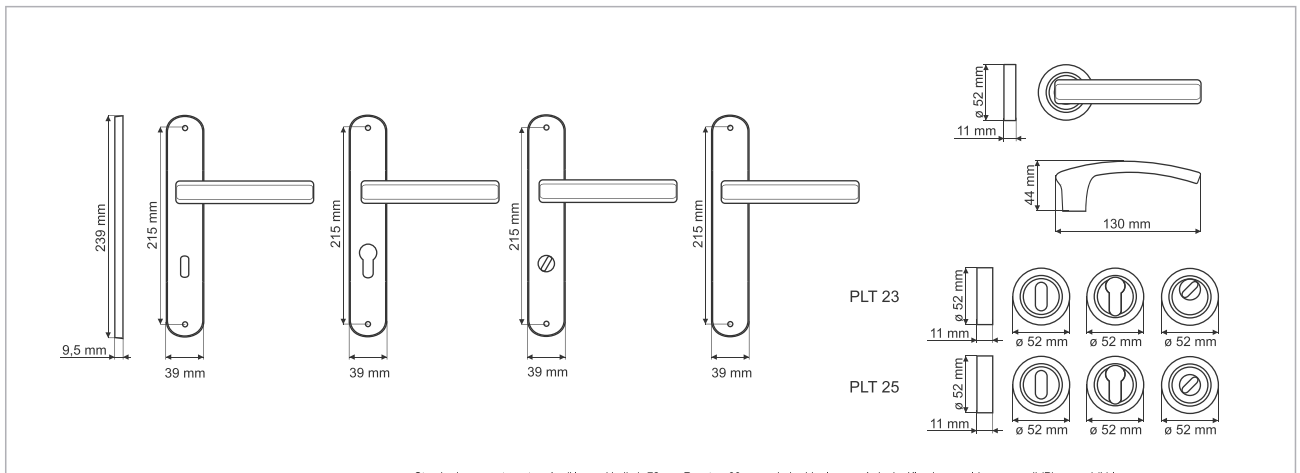

Standardowy rozstaw otworów (klucz-wkładka): 72mm, Rozstaw 90mm na indywidualne zamówienie. Klamka z szyldem w wersji (P) prawa i (L) lewa.
Standard c.c. (key-insert): 72 mm, c.c. (key-insert): 90 mm on individual orders. Door handle on a backplate in (P) right and (L) left versions.
Lochabstand Schlüssel-Zylinderschloss : 72mm, Abstand 90mm auf individuelle Anfrage. Türdrücker mit dem Schild WC ist in 2 Varianten verfügbar: (P) rechts und (L) links.
Стандартная длина между отверстиями (ключ – вкладка): 72 мм. Длина 90 мм – только на индивидуальный заказ.
La distancia estándar entre agujeros (lave-cilindro monoblock): 72mm, La distancia de 90 mm bajo pedido de cliente. Manilla con placa disponible en versiones: derecha (P) e izquierda (L).
Espacement d'orifices standard (def-insert) : 72 mm, Espacement 90 mm sur commande, Poignée avec plaque en version (P) droite et (L) gauche.



DH-R QUADRA

ZnAl



DH-R-22-06-KW



PLT-23-N-06-KW



PLT-23-Y-06-KW



PLT-23WC-06-KW

New!



PLT-25-N-06-KW



PLT-25-Y-06-KW



PLT-25WC-06-KW



G0004



G0006



G0007



G0008



G00AB

G0004 - chrom / chrome
Chrom glänzend / хром
cromo / chrome

G0006 - nikiel satynowy / satin nickel
Nickel satiniert (matt) / сатиновый никель
níquel satinado / nickel satiné

G0007 - nikiel szczotkowany / brushed nickel
Nickel gebürstet (Edelstahloptik) / крацованный никель
níquel cepillado / nickel brossé

G0008 - chrom satynowy / satin chrome
Chrom satiniert (matt) / сатиновый хром
cromo satinado / chrome satiné

G00AB - mosiądz antyczny / antique brass
Antikmessing / античная латунь
latón antiguo / laitón antique

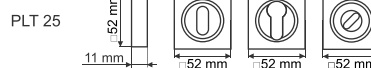
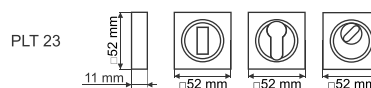
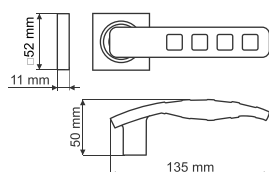

DH-R QUADRA

ZnAl



G0004 - chrom / chrome
Chrom glänzend / хром
cromo / chrome

G0006 - nikiel satynowy / satin nickel
Nickel satiniert (matt) / сатиновый никель
niquel satinado / nickel satiné

G0007 - nikiel szczotkowany / brushed nickel
Nickel gebürstet (Edelstahloptik) / крацованный никель
niquel cepillado / nickel brossé

G0008 - chrom satynowy / satin chrome
Chrom satiniert (matt) / сатиновый хром
cromo satinado / chrome satiné

G00AB - mosiądz antyczny / antique brass
Antikmessing / античная латунь
latón antiguo / laiton antique

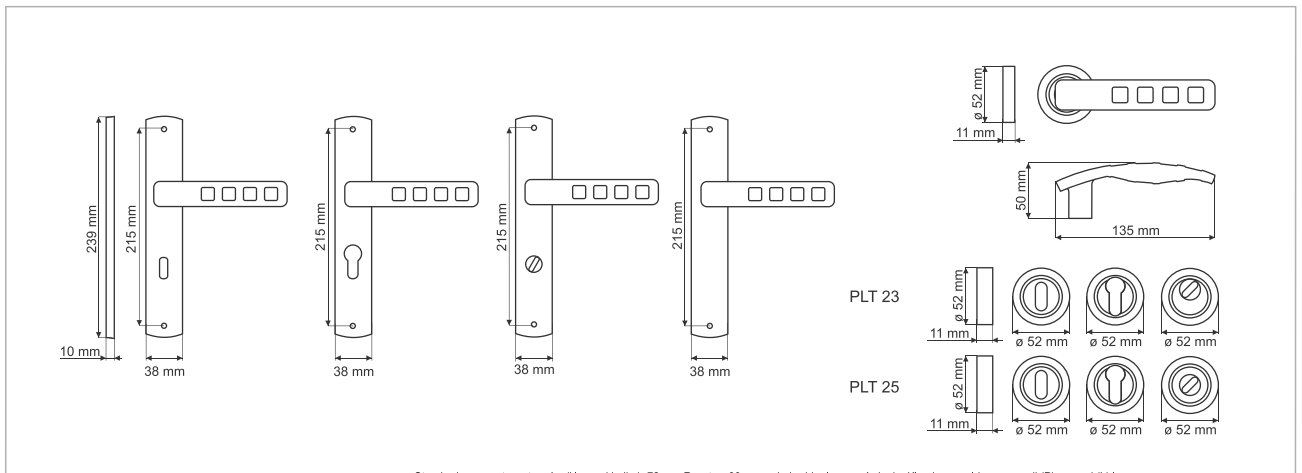

Standardowy rozstaw otworów (klucz-wkładka): 72mm, Rozstaw 90mm na indywidualne zamówienie. Klamka z szyldem w wersji (P) prawa i (L) lewa.
Standard c.c. (key-insert): 72 mm, c.c. (key-insert): 90 mm on individual orders. Door handle on a backplate in (P) right and (L) left versions.
Lochabstand Schlüssel-Zylinderschloss : 72mm, Abstand 90mm auf individuelle Anfrage. Türdrücker mit dem Schild WC ist in 2 Varianten verfügbar: (P) rechts und (L) links.
Стандартная длина между отверстиями (ключ – вкладка): 72 мм. Длина 90 мм – только на индивидуальный заказ.
La distancia estándar entre agujeros (lave-cilindro monoblock): 72mm, La distancia de 90 mm bajo pedido de cliente. Manilla con placa disponible en versiones: derecha (P) e izquierda (L).
Espacement d'orifices standard (def-insert) : 72 mm, Espacement 90 mm sur commande. Poignée avec plaque disponible en version (P) droite et (L) gauche.



Klamki
wewnętrzne

Internal door
handles

Innenraum
Türdrücker

Ручки для
внутренних дверей

Manillas
internas

Poignées
intérieures

DH-S SCIVI

ZnAl



DH-S-111N-72-06



DH-S-111Y-72-06



DH-S-111WC-06 -P



PLT-23-N-06



PLT-25-N-06



DH-S-22-06



PLT-23-Y-06



PLT-25-Y-06



PLT-23WC-06



PLT-25WC-06

New!



G0006



G0007



G00AB

G0006 - nikiel satynowy / satin nickel
Nickel satiniert (matt) / сатиновый никель
niquel satinado / nickel satiné

G0007 - nikiel szczotkowany / brushed nickel
Nickel gebürstet (EdelstahlOptik) / крацованный никель
niquel cepillado / nickel brossé

G00AB - mosiądz antyczny / antique brass
Antikmessing / античная латунь
latón antiguo / laiton antique

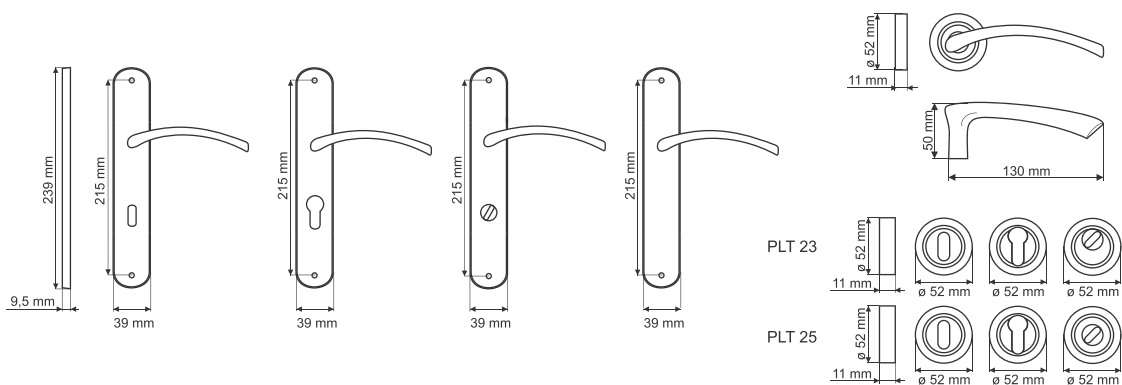

Standardowy rozstaw otworów (klucz-wkładka): 72mm. Rozstaw 90mm na indywidualne zamówienie. Klamka z szyldem w wersji (P) prawa i (L) lewa.
Standard c.c. (key - insert): 72 mm, c.c. (key - insert): 90 mm on individual orders. Door handle on a backplate in (P) right and (L) left versions.
Lochabstand Schlüssel-Zylinderschloss : 72mm. Abstand 90mm auf individuelle Anfrage. Türdrücker mit dem Schild WC ist in 2 Varianten verfügbar: (P)- rechts und (L) -links.
Стандартная длина между отверстиями (ключ - вкладка): 72 мм. Длина 90 мм - только на индивидуальный заказ.
La distancia estándar entre agujeros (llave-cilindro monoblock): 72mm. La distancia de 90 mm bajo pedido de cliente. Manilla con placa disponible en versiones: derecha (P) e izquierda (L).
Espacement d'orifices standard (def-insert) : 72 mm. Espacement 90 mm sur commande. Poignée avec plaque en version (P) droite et (L) gauche.

DH-T TALIA

ZnAl



G0003



G0004



G0006



G0007



G0008



G00AB

G0003 - mosiądz / brass
Messing / латунь
latón / laiton

G0004 - chrom / chrome
Chrom glänzend / хром
cromo / chrome

G0006 - nikiel satynowy / satin nickel
Nickel satiniert (matt) / сатиновый никель
níquel satinado / nickel satiné

G0007 - nikiel szczotkowany / brushed nickel
Nickel gebürstet (Edelstahloptik) / крацованный никель
níquel cepillado / nickel brossé

G0008 - chrom satynowy / satin chrome
Chrom satiniert (matt) / сатиновый хром
cromo satinado / chrome satiné

G00AB - mosiądz antyczny / antique brass
Antikmessing / античная латунь
latón antiguo / laiton antique

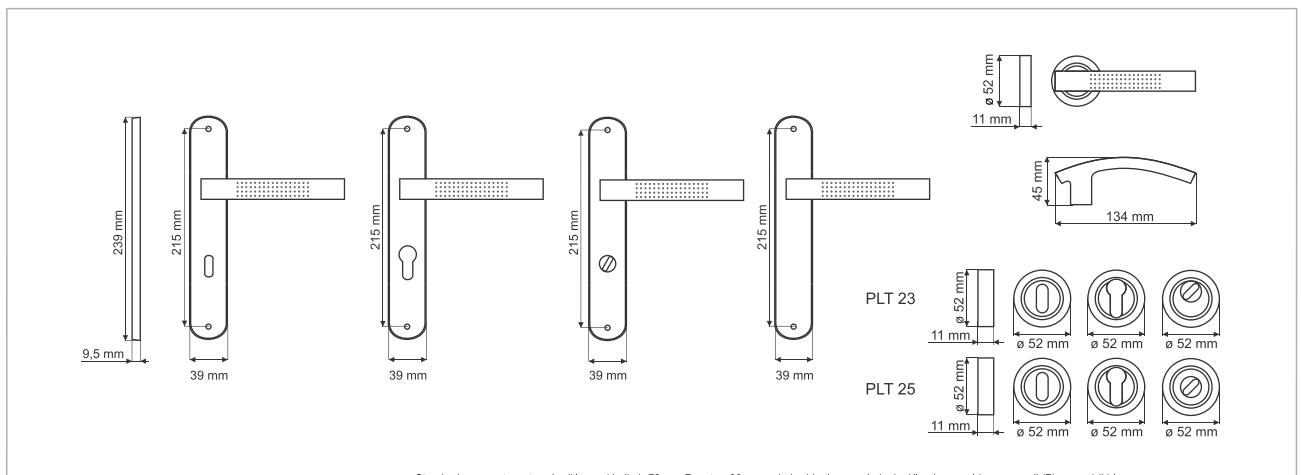

Standardowy rozstaw otworów (klucz-wkładka): 72mm, Rozstaw 90mm na indywidualne zamówienie. Klamka z szyldem w wersji (P) prawa i (L) lewa.
Standard c.c. (key-insert): 72 mm, c.c. (key-insert): 90 mm on individual orders. Door handle on a backplate in (P) right and (L) left versions.
Lochabstand Schlüssel-Zylinderschloss : 72mm, Abstand 90mm auf individuelle Anfrage. Türdrücker mit dem Schild WC ist in 2 Varianten verfügbar: (P) rechts und (L) links.
Стандартная длина между отверстиями (ключ – вкладка): 72 мм. Длина 90 мм – только на индивидуальный заказ.
La distancia estándar entre agujeros (lave-cilindro monoblock): 72mm, La distancia de 90 mm bajo pedido de cliente. Manilla con placa disponible en versiones: derecha (P) e izquierda (L).
Espacement d'orifices standard (def-insert) : 72 mm, Espacement 90 mm sur commande, Poignée avec plaque en version (P) droite et (L) gauche.



■ Szyldy / Backplates / Die Schilder / Накладки / Placas / Plaques

PLT-23

ZnAl, szyldy montowane na elemencie tworzywowym / ZnAl, backplates fixed on a plastic part

ZnAl – die Schilder auf dem Kunststoff-Einsatz montiert / ZnAl, накладки монтируются на пластиковом элементе

Placas de Zamak montadas en un elemento de plástico / ZnAl, plaques montées sur un élément en plastique



PLT-23-N-03

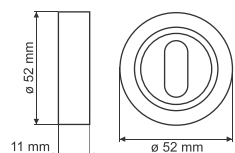

PLT-23-N-03-KW

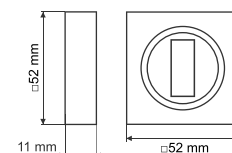

PLT-23-Y-04

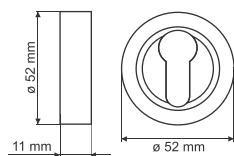

PLT-23-Y-04-KW

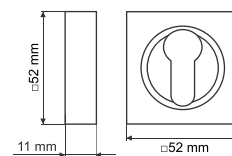

PLT-23WC-AB

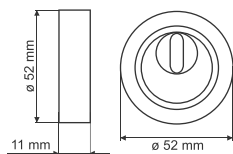

PLT-23WC-AB-KW

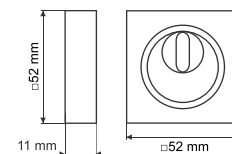

PLT-23-07-KW



PLT-23S-Y-06

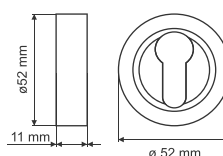

①	②	③	④
PLT 23S	Y	G0003	20
PLT 23S	Y	G0004	20
PLT 23S	Y	G0006	20
PLT 23S	Y	G0007	20
PLT 23S	Y	G0008	20
PLT 23S	Y	G00AB	20

New!

Szyldy / Backplates / Die Schilder / Накладки / Placas / Plaques ■

PLT-25

ZnAL, szyldy montowane na elemencie metalowym / ZnAl, backplates fixed on a metal part
 Znal – die Schilder auf dem Metall-Einsatz montiert / Znal, накладки монтируются на металлическом элементе
 Placas de Zamak montadas en un elemento de metal / ZnAL, plaques montées sur un élément métallique

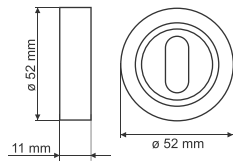

PLT-25-N-06

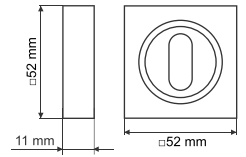

PLT-25-N-06-KW

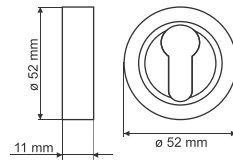

PLT-25-Y-04

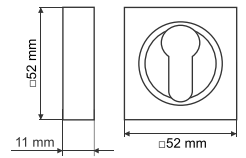

PLT-25-Y-04-KW

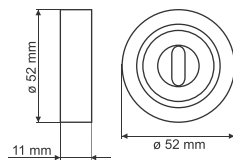

PLT-25WC-AB

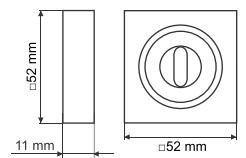

PLT-25WC-AB-KW